

# EV3 MVC & EVD MVC

Controllers for mechanical ventilation units for air renewal and heat recovery



**Important**

Read this manual carefully before installation and before using the devices and take all the prescribed precautions. Keep this manual with the devices for future consultation.

Only use the devices in the ways described in this manual. Do not use these devices as safety devices.

**Disposal**

The devices must be disposed of according to local regulations governing the collection of electrical and electronic waste.

In accordance with the Declaration of Conformity to the EU R&TTE Directive, model EVJ LCD with a built-in Bluetooth low energy sensor may be used in the following nations: Austria, Belgium, Cyprus, the Czech Republic, Denmark, Estonia, Finland, France, Germany, Greece, Hungary, Ireland, Italy, Latvia, Lithuania, Luxemburg, Malta, Norway, Poland, Portugal, Slovakia, Slovenia, Spain, Sweden, Switzerland, the Netherlands and the United Kingdom.

## SUMMARY

1	INTRODUCTION .....	5
1.1	Models available, purchasing codes and technical features .....	5
2	DESCRIPTION .....	7
2.1	Description of EV3 MVC .....	7
2.2	Description of EVD MVC .....	8
2.3	Description of EV3K11 .....	9
2.4	Description of EVJ LCD .....	10
3	MEASUREMENTS AND INSTALLATION .....	11
3.1	Measurements and installation of EV3 MVC .....	11
3.2	Measurements and installation of EVD MVC .....	11
3.3	Measurements and installation of EV3K11 .....	12
3.4	Measurements and installation of EVJ LCD .....	13
3.4.1	Models for wall mounting .....	13
3.4.2	Models for wall mounting with back-slot for flush mounting box .....	13
3.5	Installation precautions .....	14
4	USER INTERFACE .....	15
4.1	Key functions .....	15
4.2	Display .....	16
4.2.1	HOME PAGE .....	16
4.2.2	Icons .....	16
4.3	LED EVD MVC .....	19
5	ELECTRICAL CONNECTION .....	20
5.1	Example of EV3 MVC electrical connection .....	20
5.2	Example of EVD MVC electrical connection .....	21
5.3	Example 1 of EV3K11 electrical connection .....	22
5.4	Example of EVJ LCD electrical connection .....	23
5.4.1	Models for wall mounting .....	23
5.4.2	Models for wall mounting with back-slot for in-wall box .....	25
5.5	Description of connectors .....	26
5.5.1	Description of connectors for EV3 MVC .....	26
5.5.2	Description of connectors for EVD MVC .....	28
5.5.3	Description of EV3K11 connectors .....	29
5.5.4	Description of connectors for EVJ LCD .....	30
5.6	Termination resistor for the RS-485 MODBUS line .....	31
5.7	Precautions for electrical connection .....	32
6	Menu .....	33
6.1.1	Access levels .....	33
6.1.2	Menu settings .....	33
6.2	Quick menus .....	34
6.2.1	Time band setpoint (EVJ LCD only) .....	34
6.2.2	Time band settings (EVJ LCD only) .....	34
6.2.3	Enabling time bands .....	35
7	SELECTING THE OPERATING MODES .....	36
7.1	Selecting the heating/cooling mode .....	36
7.2	Selecting the time band mode .....	36
7.2.1	Manual mode (t01 = 0) .....	36
7.2.2	Time band mode (t01 = 1) .....	36
7.2.3	Holiday mode (t01 = 2 or 3) .....	37
8	CONFIGURING A DEVICE .....	38

8.1	Parameters .....	38
8.2	Configuring inputs .....	43
8.2.1	Configuring input functions .....	44
8.2.2	Universal input type configuration.....	45
8.3	Analogue Output Configuration.....	45
8.3.1	Configuring type AO.....	45
8.3.2	Exclusions .....	46
8.3.3	Configuring AO function.....	46
8.4	Configuring triac and open collector outputs.....	46
8.5	Configuring digital outputs .....	47
9	SERIAL PORTS .....	48
10	FUNCTIONING OF THE CONTROLLER .....	49
10.1	Regulation in the incremental neutral zone .....	49
10.2	Activating free heating/cooling .....	49
10.2.1	Summer mode (free-cooling) .....	49
10.2.2	Winter mode (free-heating) .....	49
10.3	Regulating the ventilation .....	50
10.3.1	External air damper .....	50
10.4	Regulating the recovery heat exchanger .....	50
10.4.1	Defrosting cross-flow or rotary recovery heat exchanger .....	51
10.5	Regulating the mixing chamber damper.....	51
10.6	Temperature regulation .....	52
10.6.1	Treatment coils .....	52
10.6.2	Winter pre-heating (Hot Start) .....	53
10.6.3	Off-band mode activation .....	53
10.7	Regulating the compressor.....	53
10.7.1	Defrosting the refrigeration circuit .....	54
10.8	Constant capacity/pressure regulation.....	54
10.9	CO <sub>2</sub> regulation .....	55
10.10	Humidity regulation .....	55
10.10.1	Winter dehumidification.....	55
10.10.2	Summer dehumidification .....	55
10.10.3	Humidification .....	56
10.11	External air limitation .....	56
11	INTERNAL STATUS .....	56
12	SIGNALS AND ALARMS .....	60
13	ACCESSORIES .....	64
13.1	INTRABUS/RS-485 EVIF22ISX serial interface .....	64
13.2	RS-485/USB EVIF20SUXI serial interface .....	65
13.3	0025100010 drip protector .....	66
13.4	CJAV connection kit.....	66
14	TECHNICAL SPECIFICATIONS .....	67

## 1 INTRODUCTION

EV3 MVC and EVD MVC are controllers for mechanical ventilation units for air renewal and handling, capable of complying with the most rigorous standards for air-quality and building energy certification.

Independent management of the supply and extraction fans, makes possible optimum flow distribution in all situations. Environmental comfort, in terms of temperature and humidity, is achieved by the ability to manage different heat recovery systems, with free-cooling and free-heating functions, and sources of heating/cooling.

EVCO offers the MVC solution in both the compact EV3 version (12 VAC and panel installation) and the split EVD version (115... 230 VAC and DIN rail installation). In both cases it is possible to connect, according to your needs, the stylish EVJ LCD remote user interface (wall-mounted) or the EV3K11 reduced-depth interface (panel fitting).

With 6 capacitive keys and an optional Bluetooth BLE communication module, EVJ LCD provides end-users with easy, intuitive control of the unit using the EVcontrol APP for iOS and Android platforms, transforming your smartphone or tablet into a state-of-the-art remote control.

Fully protected by a white list, your mobile device becomes a handy tool for adjusting the function mode (heating/cooling), temperature and humidity set-points, fan speed and timer settings. Any alarm events are displayed in real time and can be sent directly to your assistance centre.

EVcontrol is compatible with Android 4.4 and iOS devices, with Bluetooth 4.0 (BLE) or later versions.

### 1.1 Models available, purchasing codes and technical features

The table below shows the models available, the purchasing codes and the technical features of the devices.

The technical features of EVJ LCD depends on the kind of model.

Models available	EV3 MVC	EVD MVC	EV3K11	EVJ LCD
<b>Version</b>				
blind		•		
built-in LED (4+4 digit)	•		•	
built-in LCD (3+4 digit)				•
<b>Connections</b>				
Micro-Fit connectors	•	•		
Edge connectors	•			
fixed screw terminal blocks				•
plug-in screw terminal blocks	•	•	•	
<b>Power supply</b>				
12 VAC not insulated	•			
12 VAC/DC not insulated			•	•
115... 230 VAC insulated		•		•
<b>Configurable inputs</b>				
NTC or dry contact	5	5		2 (not used)
NTC/4-20 mA/0-10 V or dry contact	2	2		
<b>Digital inputs</b>				
dry contact/tachometric	2	2		
dry contact	1	1		
<b>Analogue outputs</b>				
0-10 V/PWM/phase cutting	2	2		
<b>Digital outputs (electro-mechanical relays; A res. @ 250 VAC)</b>				
Relays	4	4		2 (not used)

Models available	EV3 MVC	EVD MVC	EV3K11	EVJ LCD
<b>Digital outputs (triac; A res. @ 250 VAC)</b>				
triac	2			
<b>Digital outputs (open collector)</b>				
open collector		1		
<b>Communications ports</b>				
INTRABUS	•	•	•	•
RS-485 MODBUS	•	•		
<b>Other features</b>				
Clock	•	•		
Buzzer	•		•	•

## Purchasing codes

- EV3 MVC: **EV3934LM2** (no option)  
**EV3936LM2GF** (2 triac + RS-485 MODBUS port + clock)
- EVD MVC: **EVD934BM9MF**
- EV3K11: **EV3K11X0CT**
- EVJ LCD:

Purchasing codes	Installation mode	Power supply	External analogue inputs	Digital inputs	Incorporated temperature & humidity sensor	Incorporated Bluetooth Low Energy sensor
EVJD900N2VW	wall mounted	12 VAC/DC	1	no	no	no
EVJD900N2VWTX <sup>(1)</sup>			1	no		no
EVJD900N2VWIV			1	no		yes
EVJD920N2VW			1	no	yes	no
EVJD920N2VWIV			1	no	yes	yes
EVJD902N9VP	ewall mounted with back-slot for flush mounting box	115... 230 VAC	2	2	no	no
EVJD902N9VPIV			2	2		yes
EVJD922N9VP			2	2	yes	no
EVJD922N9VPIV			2	2		yes

<sup>(1)</sup> with RS-485 with INTRABUS communication protocol

## 2 DESCRIPTION

The following paragraphs contain a description of the various devices that can be used for the management of MVC units.

### 2.1 Description of EV3 MVC

The diagram below shows the layout of the EV3 MVC controller for panel installation in standard 74x32 mm format.

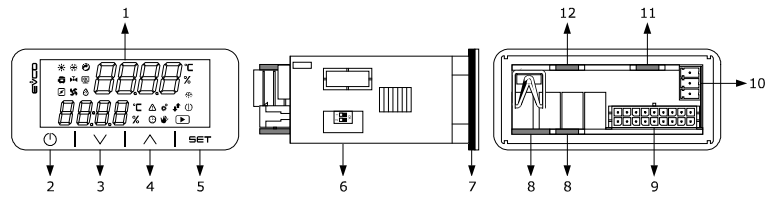

The table below describes each part of the EV3 MVC.

Part	Description
1	display
2	on/off key, subsequently also called the on/stand-by key
3	decrease key, subsequently also called the Down key
4	increase key, subsequently also called the Up key
5	setting key, subsequently also called the Set key
6	Micro-switch for the termination resistor for the RS-485 MODBUS line
7	seal
8	edge connector joint for cabling electro-mechanical relay digital outputs (for future reference, digital outputs DO1... DO4
9	male Micro-Fit connector for cabling for power, analogue inputs, digital inputs, analogue outputs and the INTRABUS port
10	plug-in screw terminal block, male only, for cabling for the RS-485 MODBUS port
11	Edge connector joint for the triac output cabling (for future reference, output TK1).
12	Edge connector joint for the triac output cabling (for future reference, output TK2).

The table gives the maximum provided.

## 2.2 Description of EVD MVC

The diagram below shows the layout of the EVD MVC for installation in an electrical panel on a DIN rail in standard 4 DIN-module format.

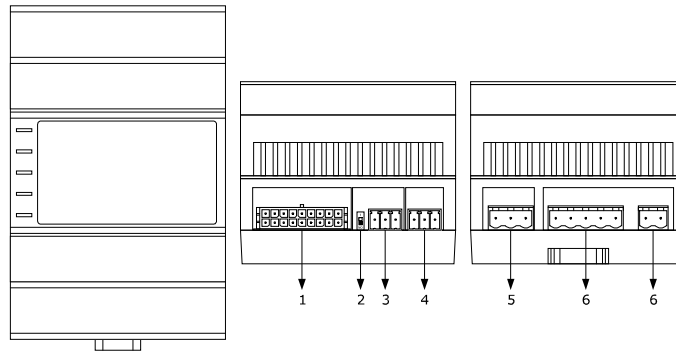

The table below describes each part of the EVD MVC.

Part	Description
1	male Micro-Fit connector for cabling for analogue inputs, digital inputs, analogue outputs and the open collector digital output (for future reference, the digital output OC1)
2	micro-switch for the termination resistor for the RS-485 MODBUS line
3	plug-in screw terminal block, male only, for cabling for the RS-485 MODBUS port
4	plug-in screw terminal block, male only, for cabling for the INTRABUS port
5	plug-in screw terminal block, male only, for cabling for the digital outputs with electro-mechanical relay (for future reference, the digital outputs DO1 and DO2)
6	plug-in screw terminal block, male only, for cabling for the power supply, electrical-mechanical relay digital outputs (for future reference, the digital outputs DO3 and DO4)



## 2.3 Description of EV3K11

The diagram below shows the layout of the EV3K11 remote keypad for panel installation in standard 74x32 mm format.

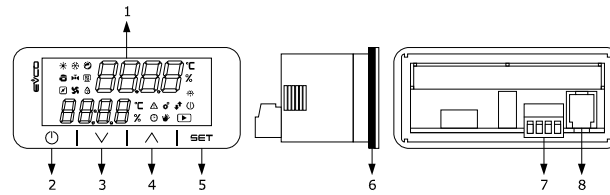

The table below describes each part of the EV3K11.

Part	Description
1	display
2	on/off key, subsequently also called the on/stand-by key
3	decrease key, subsequently also called the Down key
4	increase key, subsequently also called the Up key
5	setting key, subsequently also called the Set key
6	seal
7	male + female plug-in screw terminal block for cabling for the power supply and the INTRABUS port
8	unused

## 2.4 Description of EVJ LCD

The diagram below shows the layout of the EVJ LCD remote keypad for wall installation in 111.4x76.4 mm format.

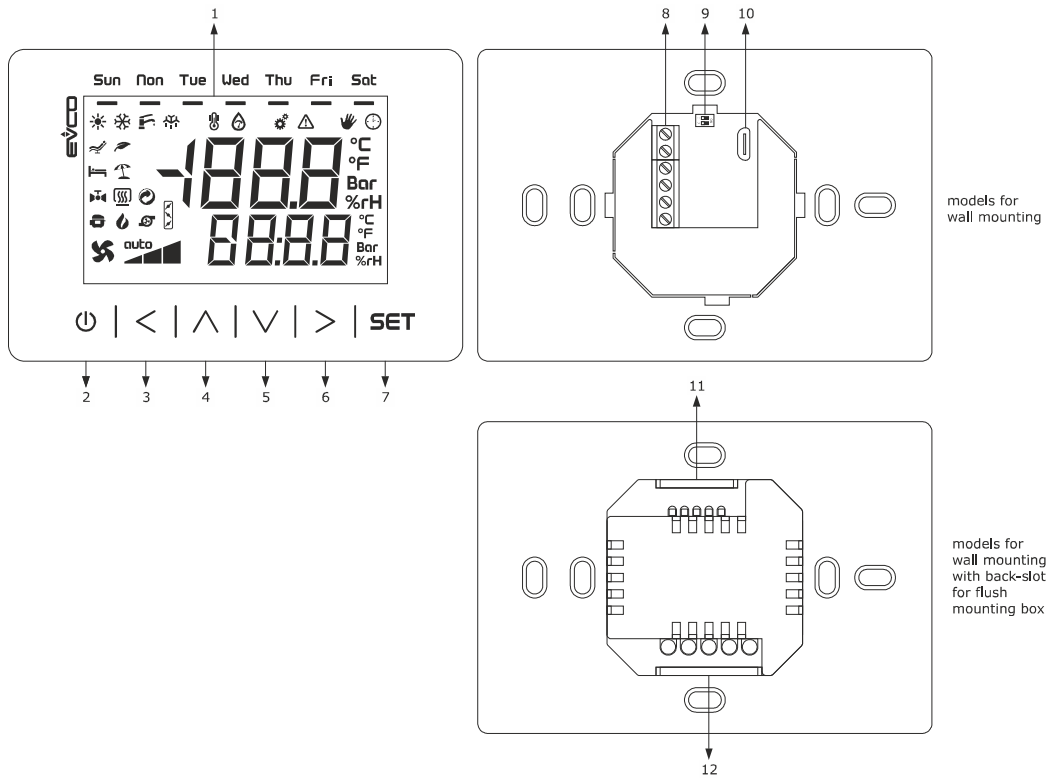

The table below describes each part of the EVJ LCD.

Part	Description
1	multi-functional display
2	on/off key, subsequently also called the on/stand-by key
3	left key, subsequently also called the Left key
4	increase key, subsequently also called the Up key
5	decrease key, subsequently also called the Down key
6	right key, subsequently also called the Right key
7	setting key, subsequently also called the Set key
8	screw terminal block for cabling for the power supply and the INTRABUS port
9	unused
10	unused
11	screw terminal block, for cabling for the analogue inputs and the INTRABUS port
12	screw terminal block, for cabling for the power supply

The table gives the maximum provided.

### 3 MEASUREMENTS AND INSTALLATION

#### 3.1 Measurements and installation of EV3 MVC

The pictures below show the measurements of EV3 MVC; measurements are expressed in mm (inches).

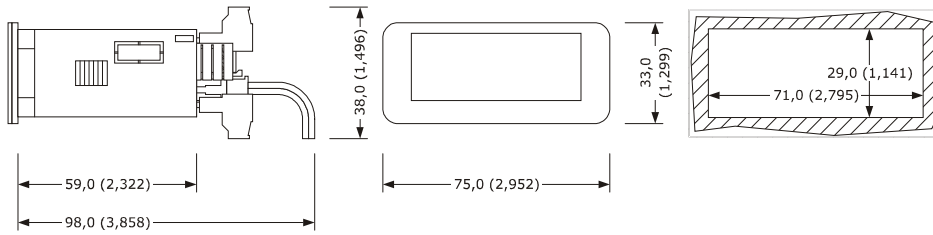

To be installed on a panel with the snap-in brackets provided.

The thickness of the panel on which EV3 MVC is to be installed must be between 0.8 and 2.0 mm (0.031 and 0.078 in).

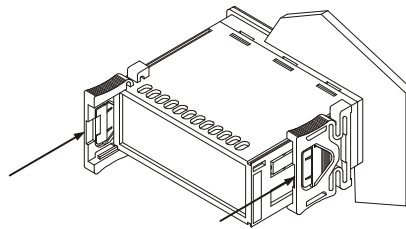

#### 3.2 Measurements and installation of EVD MVC

The picture below shows the measurements of EVD MVC (4 DIN modules); measurements are expressed in mm (inches).

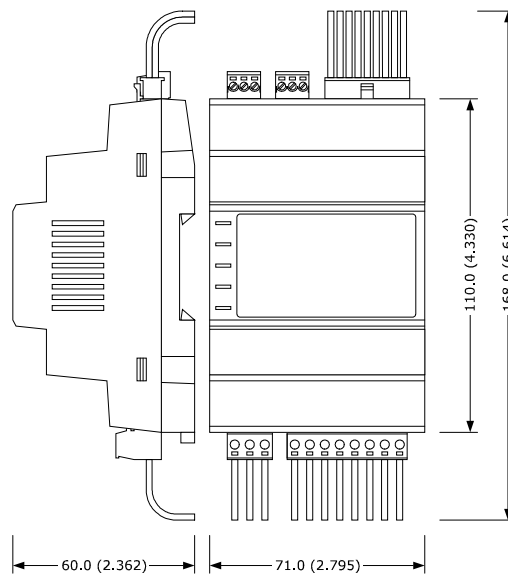

Installation is on a DIN rail 35.0 x 7.5 mm (1.377 x 0.295 in) or 35.0 x 15.0 mm (1.377 x 0.590 in), in a control panel.

The pictures below show how to install the EVD MVC.

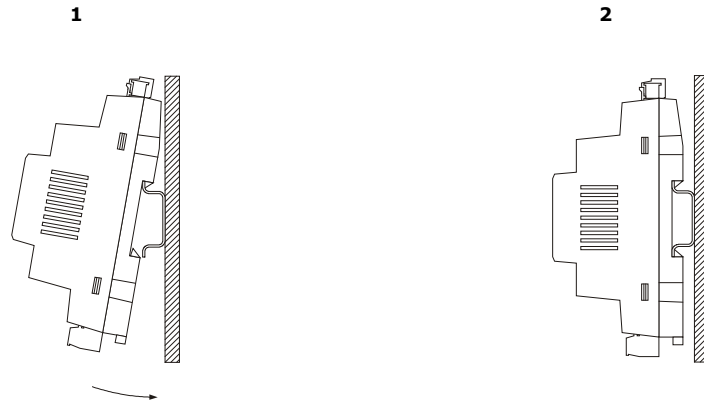

To remove the EVD MVC, first remove any plug-in screw terminal blocks fitted in the lower part, then, using a screwdriver, loosen the DIN rail clip, as shown in the pictures below.

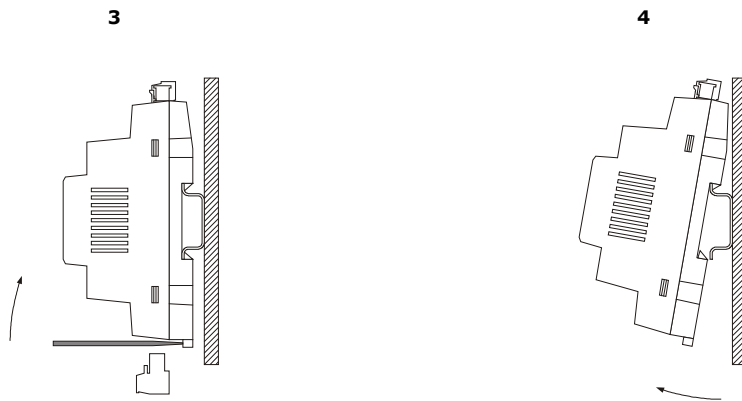

To re-install the EVD first press the DIN rail clip fully in.

### 3.3 Measurements and installation of EV3K11

The pictures below show the measurements of EV3K11; measurements are expressed in mm (inches).

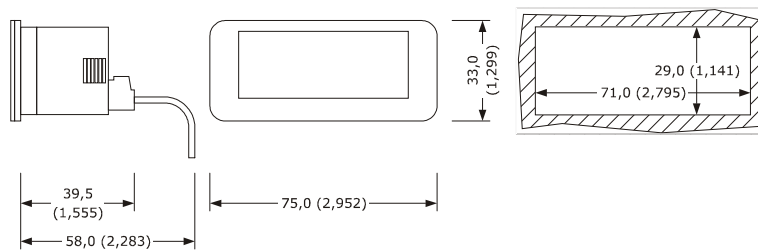

To be installed on a panel with the snap-in brackets provided.

The thickness of the panel on which the EV3K11 is to be installed must be between 0.8 and 2.0 mm (0.031 and 0.078 in).

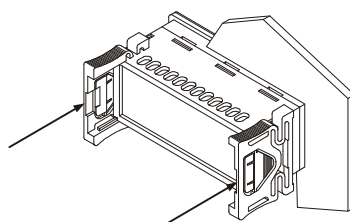

### 3.4 Measurements and installation of EVJ LCD

#### 3.4.1 Models for wall mounting

The pictures below show the measurements of EVJ LCD; measurements are expressed in mm (inches).

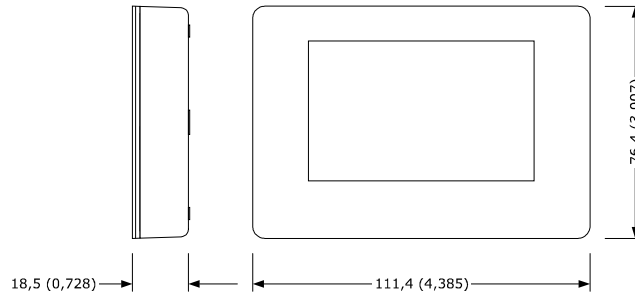

To be installed on a wall (with fixing screws and plugs) or in a 502E or 503E built-in box (with fixing screws).

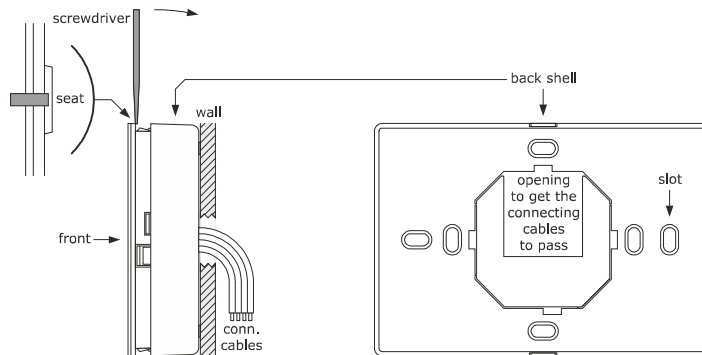

#### 3.4.2 Models for wall mounting with back-slot for flush mounting box

The pictures below show the measurements of EVJ LCD; measurements are expressed in mm (inches).

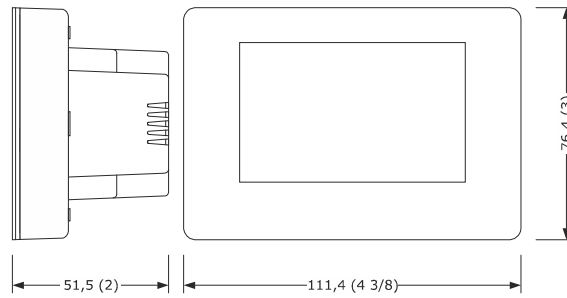

To be installed on a wall (with fixing screws and plugs) or in a 502E or 503E built-in box (with fixing screws).

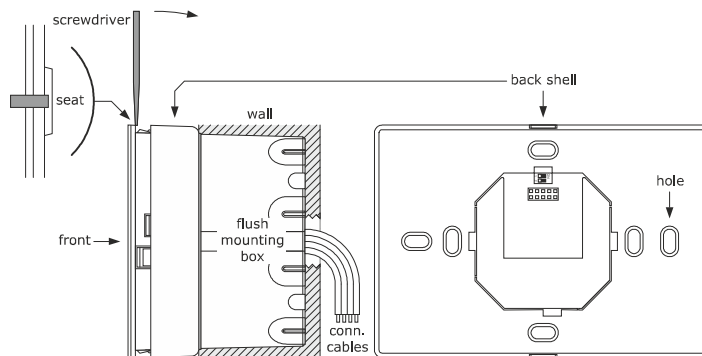









### **3.5 Installation precautions**

- Ensure that the working conditions for the devices (operating temperatures, humidity, etc.) are within the set limits. See the section TECHNICAL SPECIFICATIONS.
- Do not install the devices close to heat sources (heaters, hot air ducts, etc.), equipment with a strong magnetic field (large diffusers, etc.), in places subject to direct sunlight, rain, damp, excessive dust, mechanical vibrations or shocks.
- In compliance with safety regulations, the devices must be installed properly to ensure adequate protection from contact with electrical parts. All protective parts must be fixed in such a way as to need the aid of a tool to remove them.

## 4 USER INTERFACE

### 4.1 Key functions

The table below shows the functions of the keys.

Key EV3	Key EVD	Key EVJ	Name	Function
			On/stand-by	<ul style="list-style-type: none"> <li>- On the home page, a long press on the key ends the holiday if the holiday is active, exits from the quick menus or from the settings menu if one of them is active, otherwise it turns the device on/off.</li> <li>- On the menu pages, it acts as a 'back' or 'Esc' key, enabling settings that have not yet been confirmed to be cancelled.</li> </ul>
SET		SET	set	<ul style="list-style-type: none"> <li>- A long press on the home page allows access to the settings menu, while a short press allows access to the quick menu for setting temporary setpoints.</li> <li>- In the settings menu, a short press allows the selected value to be edited and confirmed ("enter" function).</li> </ul>
^		^	up	<ul style="list-style-type: none"> <li>- From the home page a short press gives access to the quick settings menu for enabling time bands and holidays.</li> <li>- A short press in the menus allows the user to scroll through the list or to increase the value of the variable to be modified by a set amount, if in editing mode.</li> </ul>
v		v	down	<ul style="list-style-type: none"> <li>- From the home page a long press allows the machine's operating mode to be modified, in line with the enabled operating modes, in accordance with the sequence → Cooling→ Heating → Automatic → Cooling→.</li> <li>- A short press in the menus allows the user to scroll through the list or to increase the value of the variable to be modified by a set amount, if in editing mode.</li> </ul>
-		<	left	<p>EVJ - From the home page a short press gives access to the quick menu for setting setpoint parameters.</p> <p>EV3 - Not present</p> <p>EVD - Not used</p>
-		>	right	<p>EVJ - From the home page a short press gives access to the quick menu for setting time bands.</p> <p>EV3 - Not present</p> <p>EVD - Not used</p>

## 4.2 Display

### 4.2.1 HOME PAGE

If the machine is switched off, "OFF" appears on the upper display, while the current time is shown on the lower display, provided the clock is not in error mode.

If the machine is switched on, the upper display shows the value of the room probe if the regulation is either in follow-on mode or based on the room temperature, or of the supply probe if being used for the regulation, or the thermostat input status if one of the digital inputs has been so configured.

The lower display shows the current alarm or a choice of the time, humidity, operating temperature setpoint, external temperature, fan speed or fan pressure capacity/differential (parameter C20).

From this page:

- a short press on the Set key gives access to the quick menu for setting temporary setpoints;
- a long press of the Set key gives access to the settings menu;
- a long press of the Esc key exits holiday mode, if active, or switches the machine on or off;
- a short press on the Left key gives access to the quick menu for setting setpoints;
- a short press on the Right key gives access to the quick menu for setting time bands;
- a long press on the Down key allows the machine's operating mode to be modified, in line with the enabled operating modes, in accordance with the sequence... → cooling→ heating → automatic → cooling→ ...
- a short press on the Up key gives access to the quick menu for enabling time bands and holidays.

### 4.2.2 Icons

The icons have four flashing modes:

- Slow flash: 0.5 Hz
- Normal flash: 1 Hz
- Rapid flash: 2.5 Hz
- Flash every 5 sec (1 sec off, 4 sec on)

EV3 MVC and EV3K11 display

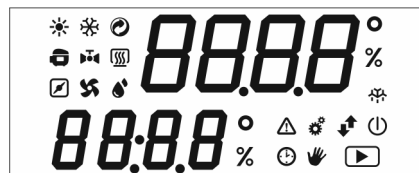



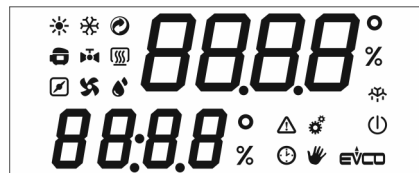



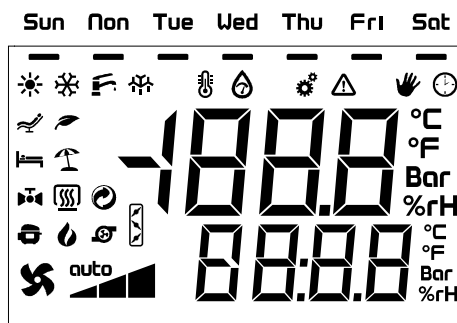











EVD MVC display (Built-in - Optional)







EVJ LCD display





EVJ LCD	EV3 MVC, EVD MVC and EV3K11	Description
		<p>heating and cooling. Depending on the value of the C21 parameter, the following activation modes apply:</p> <ul style="list-style-type: none"> <li>- C21 = 0  active in cooling mode and  active in heating mode</li> <li>- C21 = 1  active in heating mode and  active in cooling mode - flashing slowly if the "automatically change operating mode" function is active</li> </ul>
		<p>Recovery heat exchanger:</p> <ul style="list-style-type: none"> <li>- ON if the recovery heat exchanger is switched on</li> <li>- OFF if the recovery heat exchanger is switched off</li> <li>- flashing if the free heating/cooling function is active</li> </ul>
		<p>Compressor:</p> <ul style="list-style-type: none"> <li>- ON if the compressor is switched on</li> <li>- OFF if the compressor is switched off</li> <li>- flashing if timing is in progress</li> </ul>
		<p>Water coil valve:</p> <ul style="list-style-type: none"> <li>- ON if the valve is open</li> <li>- OFF if the valve is shut</li> <li>- flashing if there is movement</li> </ul>
		<p>Electric coil:</p> <ul style="list-style-type: none"> <li>- ON if the coil is switched on</li> <li>- OFF if the coil is switched off</li> </ul>
		<p>Mixing chamber damper:</p> <ul style="list-style-type: none"> <li>- ON if the damper is open</li> <li>- OFF if the damper is shut</li> <li>- flashing slowly if CO<sub>2</sub> or humidity regulation is activated</li> <li>- flashing if the free heating/cooling function is active</li> <li>- flashing rapidly if the external air limitation function is activated</li> </ul>
		<p>Fans:</p> <ul style="list-style-type: none"> <li>- ON if the fans are switched on</li> <li>- OFF if the fans are switched off</li> <li>- flashing normally if timings are in progress</li> <li>- flashing every 5 seconds if in CO<sub>2</sub> or humidity regulation mode</li> <li>- flashing rapidly if the forced-air ventilation input is active</li> <li>- flashing slowly if the external air limitation function is active</li> </ul>
auto	-	<p>Fan mode:</p> <ul style="list-style-type: none"> <li>- ON if fans are in automatic regulation mode (CO<sub>2</sub>, humidity, external air limitation, forced-air ventilation, ...)</li> <li>- otherwise it is OFF</li> </ul>
	-	<p>Fan speed:</p> <ul style="list-style-type: none"> <li>- indicates the speed at which the fans are operating</li> </ul>
°C	○	Unit of measurement of the value shown on the display when the variable displayed is a temperature in °C (C59)
%rH	%	Unit of measurement of the value shown on the display when the variable displayed is a measure of humidity.
	%	Unit of measurement of the value shown on the upper display when the variable is displayed as a percentage.

		Unit of measurement of the value shown on the display when the variable displayed is a pressure in Bar. Not used
		Unit of measurement of the value shown on the display when the variable displayed is a temperature in °F (C59)
		Humidity: <ul style="list-style-type: none"> <li>- ON if dehumidifying is required</li> <li>- flashing slowly if humidifying is required</li> <li>- otherwise it is OFF</li> </ul>
		Heat regulation: <ul style="list-style-type: none"> <li>- ON if heat regulation or post-heating is required</li> <li>- otherwise it is OFF</li> </ul>
		Time bands: <ul style="list-style-type: none"> <li>- ON if time band regulation is active or when setting a parameter for the time bands in the quick menus</li> <li>- OFF if manual regulation is active</li> </ul>
		Manual: <ul style="list-style-type: none"> <li>- ON if manual regulation is active or when setting a parameter for manual setting in the quick menus</li> <li>- OFF if time band regulation is active</li> </ul>
		Comfort: <ul style="list-style-type: none"> <li>- ON if comfort time band regulation is used or when setting a comfort setpoint in the quick menus</li> <li>- otherwise it is OFF</li> </ul>
		Economy: <ul style="list-style-type: none"> <li>- ON if economy time band regulation is used or when setting an economy setpoint in the quick menus</li> <li>- otherwise it is OFF</li> </ul>
		Night: <ul style="list-style-type: none"> <li>- ON if night-time time band regulation is used or when setting a night-time setpoint in the quick menus</li> <li>- otherwise it is OFF</li> </ul>
		Holiday: <ul style="list-style-type: none"> <li>- ON if holiday time band regulation is used or when setting holiday parameters in the quick menus</li> <li>- otherwise it is OFF</li> </ul>
		Settings: <ul style="list-style-type: none"> <li>- ON if the device is not in primary view</li> <li>- OFF during normal functioning</li> </ul>
		Alarm: <ul style="list-style-type: none"> <li>- ON if an alarm is in progress</li> <li>- OFF if no alarm is in progress</li> </ul>
		Communication (not available on EVD MVC): <ul style="list-style-type: none"> <li>- flashing if communication through the INTRABUS or RS-485 port is in progress</li> <li>- otherwise it is OFF</li> </ul>
		Defrosting: <ul style="list-style-type: none"> <li>- ON if defrosting is underway</li> <li>- OFF if defrosting is not in progress or is completed</li> <li>- flashing during dripping</li> <li>- flashing slowly if timings are in progress</li> </ul>

		On/stand-by: - ON if the controller is switched off (stand-by) - OFF if the controller is switched on
		RUN (not available on EVD MVC): - always on
---		Days of the week (screen printed on the front of the EVJ LCD): - ON LED indicating the day of the week if the clock is enabled - The LED flashes indicating the day to be amended in the quick menu for setting time bands
		Not used
		Not used
		Not used

### 4.3 LED EVD MVC

The table below describes the 5 EVD MVC signalling LEDs along the side.

LED	Colour	Description
ON	GREEN	Hardware LED on if the device is powered up.
RUN	GREEN	RUN LED - ON if the controller is switched on - OFF if the controller is switched off (stand-by)
	RED	Alarm LED - ON if an alarm is in progress - OFF if no alarm is in progress
IB	AMBER	Intrabus LED - FLASHING if communication in progress - OFF if no communication in progress
RS-485	AMBER	Modbus LED - FLASHING if communication in progress - OFF if no communication in progress

## 5 ELECTRICAL CONNECTION

### 5.1 Example of EV3 MVC electrical connection

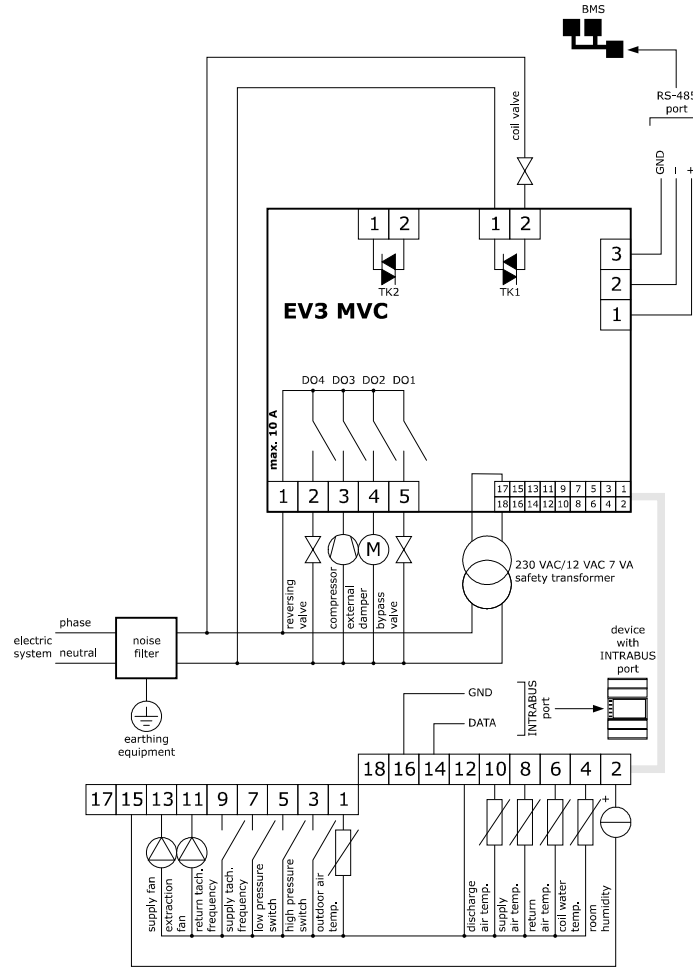

## 5.2 Example of EVD MVC electrical connection

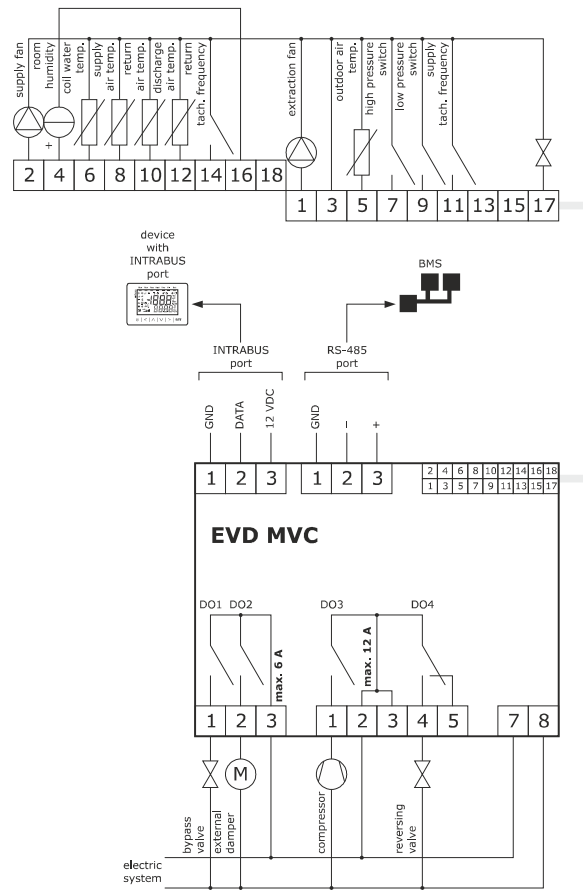

### 5.3 Example 1 of EV3K11 electrical connection

Example 1 of electrical connection: EV3K11 is powered by a safety transformer.

**N.B.:**

- Do not supply another device with the same transformer
- The maximum permitted length for connection cables of the INTRABUS port is 30 m (98.4 ft).

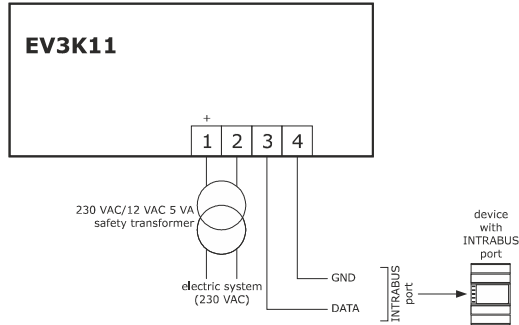

Example 2 of electrical connection: EV3K11 is powered by a device.

**N.B.:**

- Make sure that the current supplied by the controller is within the limits stated in the TECHNICAL SPECIFICATIONS section
- The maximum permitted length for connection cables of the INTRABUS port is 10 m (32.8 ft).

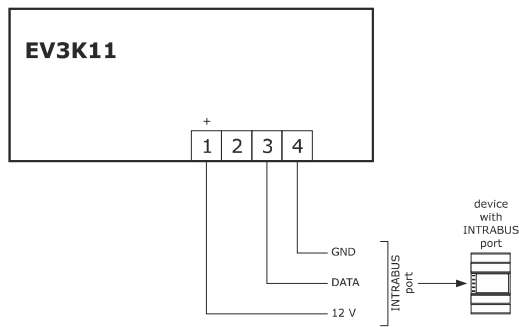

## 5.4 Example of EVJ LCD electrical connection

### 5.4.1 Models for wall mounting

Example 1 of electrical connection: EVJ LCD is powered by a safety transformer.

**N.B.:**

- Do not supply another device with the same transformer
- The maximum permitted length for connection cables of the INTRABUS port is 30 m (98.4 ft).

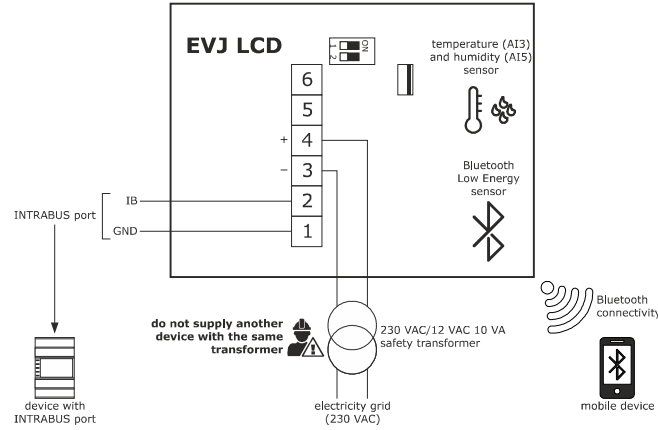

Example 2 of electrical connection: EVJ LCD is powered by a device.

**N.B.:**

- Make sure that the current supplied by the controller is within the limits stated in the TECHNICAL SPECIFICATIONS section
- The maximum permitted length for connection cables of the INTRABUS port is 10 m (32.8 ft).

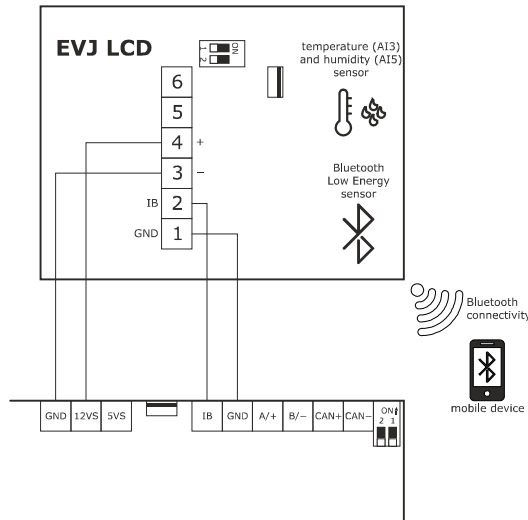

Example 2 of electrical connection: EVJ LCD has a RS-485 serial port (purchasing code EVJD900N2VWTX) with INTRABUS communication protocol and is powered by a safety transformer.

**N.B.:**

- Do not supply another device with the same transformer
- the INTRABUS/RS-485 serial interface EVIF22ISX is required
- The maximum permitted length for connection cables of the RS-485 port is 1,000 m (3,280 ft).

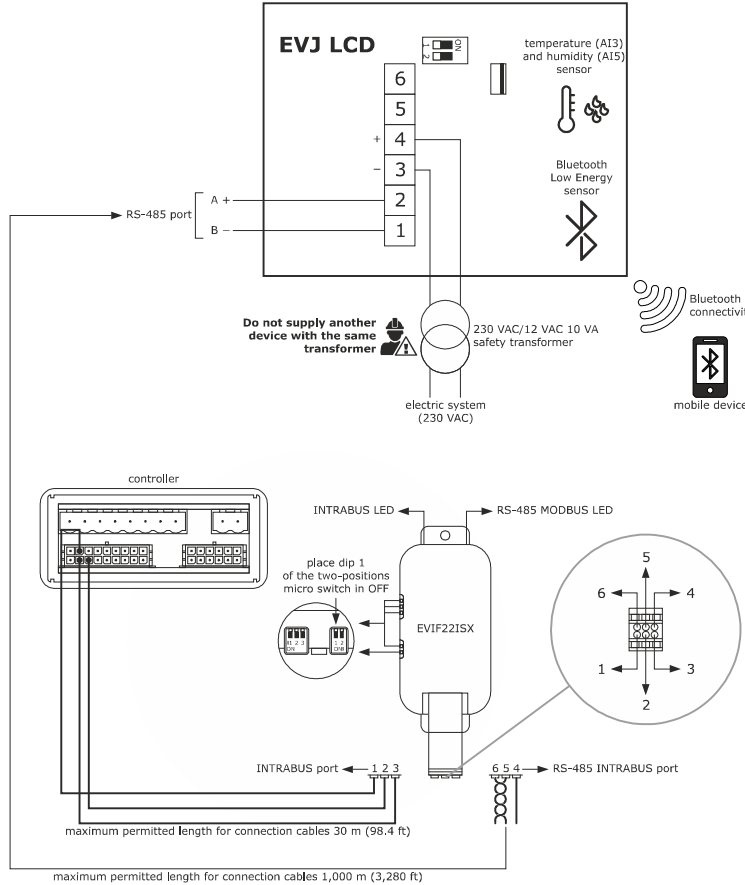

The table below describes the EVIF22ISX connectors.

Port	Part	Meaning
INTRABUS	1	12 V
	2	signal INTRABUS port
	3	reference (GND) INTRABUS port
RS-485	4	reference (GND) RS-485 port
	5	negative signal RS-485 port
	6	positive signal RS-485 port



### 5.4.2 Models for wall mounting with back-slot for in-wall box

**N.B.:**

- The maximum permitted length for connection cables of the INTRABUS port is 30 m (98.4 ft).

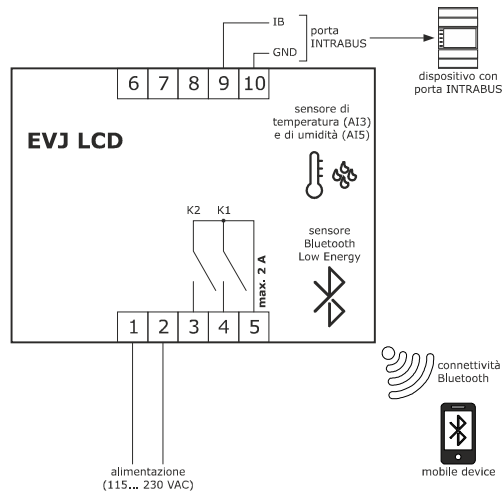

## 5.5 Description of connectors

### 5.5.1 Description of connectors for EV3 MVC

The picture below shows the layout of the EV3 MVC connectors.

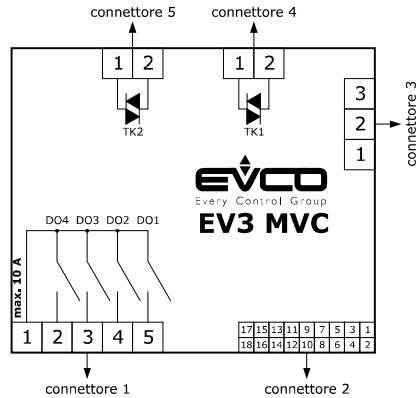

The tables below describe the EV3 MVC connectors. The tables give the maximum provided.

#### Connector 1

Part	Description
1	relay digital outputs DO1... DO4 (max. 10 A): common
2	relay digital output DO4 (3 A SPST): normally open
3	relay digital output DO3 (3 A SPST): normally open
4	relay digital output DO2 (3 A SPST): normally open
5	relay digital output DO1 (3 A SPST): normally open

#### Connector 2

Part	Description
1	Analogue input IN6
2	Analogue input IN1
3	Analogue input IN7
4	Analogue input IN2
5	Dry contact digital input/pulse input IN8
6	Analogue input IN3
7	Dry contact digital input/pulse input IN9
8	Analogue input IN4
9	Dry contact digital input IN10
10	Analogue input IN5
11	Analogue output AO1
12	Reference (GND)
13	Analogue output AO2
14	INTRABUS port signal
15	Output 12 VDC, max. 100 mA

16	Reference (GND)
17	EV3 MVC power supply (12 VAC)
18	EV3 MVC power supply (12 VAC)

**Connector 3**

Part	Description
1	Positive signal RS-485 MODBUS port
2	Negative signal RS-485 MODBUS port
3	Reference (GND)

**Connector 4**

Part	Description
1	Triac TK1 output: common
2	Triac TK1 output (200 mA): normally open

**Connector 5**

Part	Description
1	Triac TK2 output: common
2	Triac TK2 output (2 A): normally open

### 5.5.2 Description of connectors for EVD MVC

The picture below shows the layout of the EVD MVC connectors.

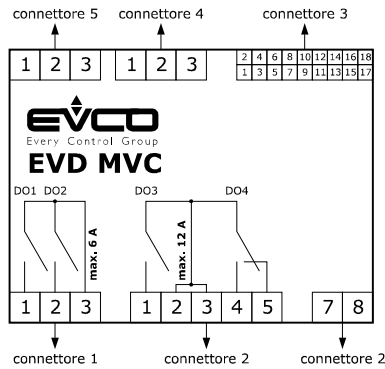

The tables below describe the EVD MVC connectors.

#### Connector 1

Part	Description
1	relay digital output NO1 (3 A SPST)
2	relay digital output NO 2 (3 A SPST)
3	relay digital outputs CO1/2 (max. 6 A): common

#### Connector 2

Part	Description
1	relay digital output DO3 (12 A SPST): normally open
2	relay digital output DO3 and D04: common
3	relay digital output DO3 and D04: common
4	relay digital output DO4 (8 A SPDT): normally open
5	relay digital output DO4 (8 A SPST): normally closed
7	EVD MVC power supply (115... 230 VAC insulated)
8	EVD MVC power supply (115... 230 VAC insulated)

#### Connector 3

Part	Description
1	Analogue output AO2
2	Analogue output AO1
3	Reference (GND)
4	Dry contact analogue/digital input IN1
5	Dry contact analogue/digital input IN10
6	Dry contact analogue/digital input IN2
7	Dry contact analogue/digital input IN9
8	Dry contact analogue/digital input IN3
9	Dry contact digital input/pulse input IN8
10	Dry contact analogue/digital input IN4

11	Dry contact digital input/pulse input IN7
12	Dry contact analogue/digital input IN5
13	GND
14	Dry contact digital input IN6
15	unused
16	12 VDC, max. 40 mA
17	Open collector digital output OC1 (12 V, max. 40 mA)
18	Reference (GND)

**Connector 4**

Part	Description
1	Reference (GND)
2	Negative signal RS-485 MODBUS port
3	Positive signal RS-485 MODBUS port

**Connector 5**

Part	Description
1	INTRABUS port reference (GND)
2	INTRABUS port signal
3	12 VDC output

**5.5.3 Description of EV3K11 connectors**

The picture below shows the layout of the EV3K11 connectors.

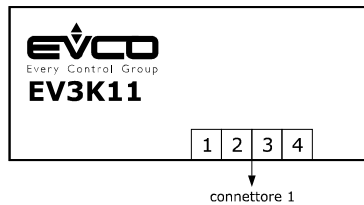

The table below describes the EV3K11 connectors.

**Connector 1**

Part	Description
1	EV3K11 (12 VAC/DC) power supply; if EV3K11 is fed by DC power, connect the positive pole
2	power supply EV3K11 and INTRABUS port reference (GND)
3	INTRABUS port signal
4	EV3K11 power supply reference (GND) and INTRABUS port

### 5.5.4 Description of connectors for EVJ LCD

#### 5.5.4.1 Models for wall mounting

The picture below shows the layout of the EVJ LCD connectors.

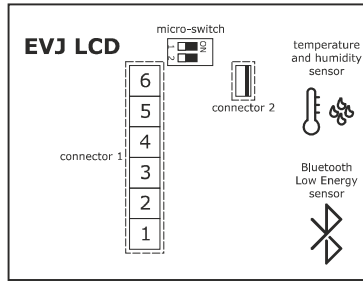

The table below describes the EVJ LCD connectors. The table gives the maximum provided.

#### Connector 1

Part	Description
1	INTRABUS port reference (GND); signal B (-) in the model with RS-485 port with INTRABUS communication protocol (purchasing code EVJD900N2VWTX)
2	INTRABUS port signal; signal A (+) in the model with RS-485 port with INTRABUS communication protocol (purchasing code EVJD900N2VWTX)
3	EVJ LCD (12 VAC/DC) power supply; if EVJ LCD is fed by DC power, connect the negative pole
4	EVJ LCD (12 VAC/DC) power supply; if EVJ LCD is fed by DC power, connect the positive pole
5	unused
6	unused

#### 5.5.4.2 Models for wall mounting with back-slot for in-wall box

The picture below shows the layout of the EVJ LCD connectors.

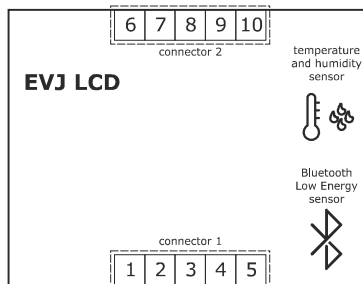

The table below describes the EVJ LCD connectors. The table gives the maximum provided.

#### Connector 1

Part	Description
1	EVJ LCD (115... 230 VAC) power supply
2	EVJ LCD (115... 230 VAC) power supply
3	unused
4	unused
5	unused

**Connector 2**

Part	Description
6	unused
7	unused
8	unused
9	INTRABUS port signal
10	INTRABUS port reference (GND)

**5.6 Termination resistor for the RS-485 MODBUS line**

To terminate the RS-485 MODBUS line of the EV3 MVC, place micro-switch 1 in position ON. Do not touch micro-switch 2.

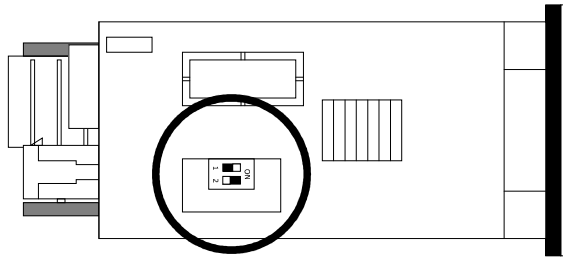

To terminate the RS-485 line of the EVD MVC, place micro-switch 1 in position ON.

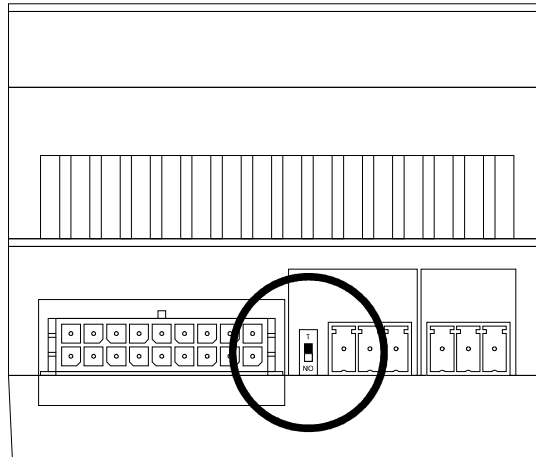

## 5.7 Precautions for electrical connection

- Do not use electric or pneumatic screwdrivers on the terminal blocks of the devices.
- If the devices have been moved from a cold to a warm place, the humidity may cause condensation to form inside. Wait about an hour before switching on the power.
- Make sure that the supply voltage, electrical frequency and power of the devices correspond to the local power supply. See the section TECHNICAL SPECIFICATIONS.
- Disconnect the devices from the power supply before doing any type of maintenance.
- The devices must be fed by power of the same phase as that feeding any module with a phase-cutting command signal.
- If TRIAC digital outputs are used it is advisable to connect a noise filter; do not touch the heat sink because it may reach very high temperatures.
- Connect the devices to the RS-485 network using a screened cable with a twisted pair for the signal and an independent third wire for connecting the reference (GND); the shield (braid) is earthed at a single point to avoid parasitic currents; a BELDEN 3106A cable or equivalent is recommended.
- Locate the power cables as far away as possible from those for the signal.
- Do not use the devices as safety devices.
- For repairs and for further information on the devices, contact the EVCO sales network.



## 6 Menu

### 6.1.1 Access levels

There are three access levels for navigating within the menus, two of which require a password:

**U** User: always visible

**S** Servicer: visible if the servicer password or the manufacturer password has been entered

**M** Manufacturer: visible if the manufacturer password has been entered.

### 6.1.2 Menu settings

A long press of the Enter key on the home page gives access to the settings menu.

**Set** Gives access to the quick setting of the regulation setpoints.

FAn: fan speed setpoint regulation

dAM: regulation of damper opening setpoint

tMP: temperature setpoint regulation

**StA** Shows machine status data

**AL** Shows the list of alarms underway

**Par** Enables the device parameters to be displayed and amended. The parameters are grouped according to their function (identified on the display by a label). Each parameter has an alphabetic code followed by two numbers, as shown in the table below:

Group	Identification label	Index
Time bands	tb	t
Setpoint	SP	P
Configuration	CnF	C
Defrosting	dEF	d
Alarm	ALM	A
Inputs/outputs	IO	I

**Hr** Shows the operating hours

HCP: compressor operating hours

HFA: fan operating hours

HUn: unit operating hours



**Press the SET key for about 3 seconds to reset the operating hours to zero if at least the service level password has been entered. This operation cancels any alarms relating to "operating hours exceeded" for the loads.**

**HiS** Enables up to 20 alarm events to be saved

ViS: the historical details are shown on the lower display in the following sequence:

nn alarm sequential number

COdAl Alarm code

y xx year if the clock is available or dozens of hours of unit ON

M xx month if the clock is available

d xx day if the clock is available

hh:mm hours:minutes if the clock is available

cLS: deletes historical details

**rtc** Enables the time to be set

YEA: set year

Mon: set month

dAY: set day of the month

UdA: set day of the week

Hou: set hour

Min: set minutes

**inFo** enables the project data to be displayed in this sequence:

Project

Variation

Revision:Version

**PAS** Enables entry of the password for accessing the desired level: parameter C18 for servicer level, C19 for manufacturer level.

## 6.2 Quick menus

If the EVJ LCD display is installed, all the quick menus are accessible; from the EV3 MVC, EVD MVC or EV3K11 displays only some of them will be accessible

P01	21,0	U	C02	C01	°C-°F	Temperature setpoint Heating mode Comfort setting
P02	25,0	U	C04	C03	°C-°F	Temperature setpoint Cooling mode Comfort setting
P03	-1,0	U	-12,7	12,7	°C-°F	Temperature offset Heating mode Economy setting
P04	1,0	U	-12,7	12,7	°C-°F	Temperature offset Cooling mode Economy setting
P05	-2,0	U	-12,7	12,7	°C-°F	Temperature offset Heating mode Night setting
P06	2,0	U	-12,7	12,7	°C-°F	Temperature offset Cooling mode Night setting
P07	21,0	U	C02	C01	°C-°F	Temperature setpoint Heating mode Manual setting
P08	25,0	U	C04	C03	°C-°F	Temperature setpoint Cooling mode Manual setting
P09	80	U	C06	C05	%	Fan speed setpoint comfort setting
P10	60	U	C06	C05	%	Fan speed setpoint economy setting
P11	40	U	C06	C05	%	Fan speed setpoint night setting
P12	80	U	C06	C05	%	Fan speed setpoint manual setting
P13	100	U	C06	C05	%	Fan speed setpoint digital input setting
P14	40	U	C08	C07	%	Damper opening setpoint comfort setting
P15	30	U	C08	C07	%	Damper opening setpoint economy setting
P16	20	U	C08	C07	%	Damper opening setpoint night setting
P17	40	U	C08	C07	%	Damper opening setpoint manual setting

### 6.2.1 Time band setpoint (EVJ LCD only)

This menu is accessed by a short press on the Left key on the Home page.

The setpoint code as per the following table is shown on the upper display, while the value is shown on the lower display. The icons help identify the value displayed. Whether or not these setpoints are visible depends on how the visibility levels of parameters P01 to P17 have been set.

Label	Description
tHC	Temperature setpoint Heating mode comfort setting
tCC	Temperature setpoint Cooling mode comfort setting
tHE	Temperature setpoint Heating mode Economy setting
tCE	Temperature setpoint Cooling mode Economy setting
tHn	Temperature setpoint Heating mode Night setting
tCn	Temperature setpoint Cooling mode Night setting
tHM	Temperature setpoint Heating mode Manual setting
tCM	Temperature setpoint Cooling mode Manual setting
FnC	Fan speed comfort setting
FnE	Fan speed Economy setting
Fnn	Fan speed Night setting
FnM	Fan speed Manual setting
Fnd	Fan speed Digital input setting
dMC	Damper opening comfort setting
dME	Damper opening Economy setting
dMn	Damper opening Night setting
dMM	Damper opening Manual setting

### 6.2.2 Time band settings (EVJ LCD only)

This menu is accessed by a short press on the Right key on the Home page. It enables the time band type and start time to be entered. To scroll through the menu, use the Up and Down keys.

Initially for each day of the week, identified by the day icon, a day type (A, B or C) is set by pressing the SET key. This allows an existing setting to be amended and confirmed.

Subsequently the band type is set for each day type along with the start time for each (4 bands for each day type). For example, the type of the first band for day type A will be A1M (M = mode), while the start time will be A1t (t = time). Press the SET key to change the existing setting and confirm the change.



**If a time band is disabled, the menu jumps directly to the next day type. Hence it is important to check that the bands following the one that you wish to disable are also disabled.**

### 6.2.3 Enabling time bands

This menu is accessed by a short press on the Up key on the home page. Press the SET key to change the existing setting and confirm the change.

This menu enables time bands to be enabled or for holidays to be set. After having pressed SET, use the Up and Down keys to see the following sequence of headings:

- OFF: enable manual mode
- On: enable time bands
- HoLi: pressing SET allows settings to be made relating to holidays (by pressing the SET key again existing values can be amended and then confirmed):
  - typ
  - Hou: set a holiday of a number of hours
  - dAy: set a holiday of a number of days
  - day/Hou: set the number of holiday hours/days desired
  - Mod
- HOFF: the machine is switched off during the holiday period
- H ON: the machine is switched on during the holiday period
- tHH: set the heating mode temperature setpoint, if the machine is switched on during the holiday
- tCH: set the cooling mode temperature setpoint, if the machine is switched on during the holiday
- FnH: set the fan speed setpoint if the machine is switched on during the holiday
- dMH: set the damper opening setpoint if the machine is switched on during the holiday

## 7 SELECTING THE OPERATING MODES

The controller always makes it possible to manage heating and cooling and use either "manual" operation or "time bands" to meet the user's needs in the best way.

### 7.1 Selecting the heating/cooling mode

There are three possibilities for selecting the operating mode:

- By digital input
- By probe (automatic)
- By keypad/supervisor.

If a digital input is configured as '*Change of operating mode*' then it is the status of this input that determines the operating mode.

If a digital input is not configured but the automatic changeover function (C11=2) is active, the machine heats up if the probe temperature configured by parameter C23 is lower than C25, while it cools down if this temperature is above C26. Parameter C24 defines the time required for the operating mode to switch.

If the changeover probe (C23) is not configured by the relative parameters (I01-I20) the configuration alarm is activated, if however, the probe is in alarm mode the relative probe alarm is activated. In both cases this inhibits the automatic change of operating mode and the machine remains in its "current" operating mode.



If the change of operating mode by digital input or automatic is active (based on the value of one of the probes provided) any attempt to change the mode from the keypad will fail and there will be no warning of the reason for the failure of the action.

If a specific digital input is not configured and the automatic changeover function (C11=0) is not active, the operating mode is set through the keypad and each time the DOWN key is held down, the operating mode will change ...-> COOL -> HEAT.

In this situation the supervisor is able to force the operating mode (S17 status).

When C11=1 (Manual + Auto) the machine can be set to operate in heating or cooling mode or even automatically through the keypad and by the supervisor. Each long press of the DOWN key changes the operating mode in the sequence ...-> COOL -> HEAT → AUTO.

### 7.2 Selecting the time band mode

The setpoints for temperature, for opening the mixing chamber damper and for the fan speed are set based on parameter *t01* and the current time. The "temporary" setpoints for temperature, fan speed and mixing chamber damper regulation (if present) can be changed from the keypad or by the supervisor in the following way:

- From the keypad by pressing the SET key and changing the values tMP, FAn, dMP
- By the supervisor by changing the status of S05 (fan speed), S09 (damper opening) and S19 (temperature).

In manual mode any change to these values is also reflected in the parameters, thus becoming final.

If the time bands are active, when a new band starts up or if the mode is changed from manual to time band or vice versa, the setpoints are reassigned according to the parameters set.

#### 7.2.1 Manual mode (t01 = 0)

Listed below are the setpoints used:

P07 manual temperature setpoint heating mode

P08 manual temperature setpoint cooling mode

P12 manual fan setpoint

P17 manual mixing chamber damper setpoint

#### 7.2.2 Time band mode (t01 = 1)

The active time band is based on the current time scrolling back in time until a valid value is found in the parameters for the time bands. If no valid mode is found (e.g. if the time band parameters t02-t32 have not been correctly set) the machine operates in manual mode.

Each day of the week can be associated with a different day type (t26-t32).

Three "day types" (A, B, C) are available each of which can have up to 4 different time bands (t02-t25).

Each band depends on the active mode, the start time and the required comfort level.

The following comfort levels are available:

- Comfort (COM) for this mode the setpoints used are provided by the following parameters:
- P01 comfort temperature setpoint heating mode (winter)
- P02 comfort temperature setpoint cooling mode (summer)
- P09 comfort fan speed setpoint
- P14 comfort mixing chamber damper setpoint

- Economy (ECO) for this level the temperature setpoints are taken from the comfort mode settings adding an offset; the fan speed and damper opening setpoints instead are controlled by the following specific parameters:

- P01+P03 economy temperature setpoint heating mode
- P02+P04 economy temperature setpoint cooling mode
- P10 economy fan speed setpoint
- P15 economy mixing chamber damper setpoint

- Night-time (NIGHT) also for this level the temperature setpoints are taken from the comfort mode settings adding a specific offset; the fan speed and damper opening setpoints instead are controlled by the following specific parameters:

- P01+P05 temperature setpoint night-time heating mode
- P02+P06 temperature setpoint night-time cooling mode
- P11 night-time fan speed setpoint
- P16 night-time mixing chamber damper setpoint

N.B. If there is a clock error, the manual mode is activated.

### **7.2.3 Holiday mode (t01 = 2 or 3)**

If a temporary suspension of the time band operating mode is required (clock enabled and not incorrect) the Holiday mode can be activated consisting of a set period starting when this is activated and ending at a particular date and time. The holiday mode can be activated for a few hours or for several months as required, with the holiday ending date and time correctly set (parameters t33-t36), after which there will be a return to the situation prior to the holiday mode setting.

The holiday mode can have two variants: with the machine on or with the machine off (the word OFFt appears on the display) configured by setting parameter t01 to 2 or 3 respectively. The mode of operation starts when the parameter value is confirmed by pressing the SET key.

In "Holiday ON" mode the manual mode setpoints are used:

- P07 manual temperature setpoint heating mode
- P08 manual temperature setpoint cooling mode
- P12 manual fan setpoint
- P17 manual mixing chamber damper setpoint

## 8 CONFIGURING A DEVICE

The following paragraphs list all the possible configurations of the EV3 and EVD MVC devices.

### 8.1 Parameters

For each parameter a visibility level is assigned that can be modified (only from serial port) with 4 possible values (the visibility value controls the level of the password to be entered in order to access the relative parameter via the keypad):

0 = Hidden (H)

1 = User (U)

2 = Servicer (S)

3 = Manufacturer (M)

Label	Default value	Default visibility	Min	Max	um	Description
<b>TBD</b>						<b>Time Band Parameters</b>
t01	0	U	0	3		Time Band Mode 0: OFF 1: ON 2: Holiday ON 3: Holiday OFF
t02	26	U	0:00	23:45	15 min	Start time band 1 type A
t03	2	U	0	4		Band 1 type A mode 0: Disabled 1: OFF 2: Comfort 3: Economy 4: Night
t04	32	U	0:00	23:45	15 min	Start time band 2 type A
t05	3	U	0	4		Band 2 type A mode
t06	64	U	0:00	23:45	15 min	Start time band 3 type A
t07	2	U	0	4		Band 3 type A mode
t08	84	U	0:00	23:45	15 min	Start time band 4 type A
t09	4	U	0	4		Band 4 type A mode
t10	28	U	0:00	23:45	15 min	Start time band 1 type B
t11	2	U	0	4		Band 1 type B mode
t12	40	U	0:00	23:45	15 min	Start time band 2 type B
t13	3	U	0	4		Band 2 type B mode
t14	64	U	0:00	23:45	15 min	Start time band 3 type B
t15	2	U	0	4		Band 3 type B mode
t16	88	U	0:00	23:45	15 min	Start time band 4 type B
t17	4	U	0	4		Band 4 type B mode
t18	28	U	0:00	23:45	15 min	Start time band 1 type C
t19	2	U	0	4		Band 1 type C mode
t20	40	U	0:00	23:45	15 min	Start time band 2 type C
t21	3	U	0	4		Band 2 type C mode
t22	48	U	0:00	23:45	15 min	Start time band 3 type C
t23	2	U	0	4		Band 3 type C mode
t24	88	U	0:00	23:45	15 min	Start time band 4 type C
t25	4	U	0	4		Band 4 type C mode
t26	0	U	0	2		Band type for Monday 0: Type A 1: Type B 2: Type C
t27	0	U	0	2		Band type for Tuesday
t28	0	U	0	2		Band type for Wednesday
t29	0	U	0	2		Band type for Thursday

Label	Default value	Default visibility	Min	Max	um	Description
t30	0	U	0	2		Band type for Friday
t31	1	U	0	2		Band type for Saturday
t32	2	U	0	2		Band type for Sunday
t33	16	U	0	100		Holiday end year
t34	1	U	1	12		Holiday end month
t35	1	U	1	31		Holiday end day
t36	0	U	0	23		Holiday end hour
<b>SP</b>						<b>Setpoint Parameters</b>
P01	21.0	U	C02	C01	°C-°F	Temperature setpoint Heating mode Comfort setting
P02	25.0	U	C04	C03	°C-°F	Temperature setpoint Cooling mode Comfort setting
P03	-1.0	U	-12.7	12.7	°C-°F	Temperature offset Heating mode Economy setting
P04	1.0	U	-12.7	12.7	°C-°F	Temperature offset Cooling mode Economy setting
P05	-2.0	U	-12.7	12.7	°C-°F	Temperature offset Heating mode Night setting
P06	2.0	U	-12.7	12.7	°C-°F	Temperature offset Cooling mode Night setting
P07	21.0	U	C02	C01	°C-°F	Temperature setpoint Heating mode Manual setting
P08	25.0	U	C04	C03	°C-°F	Temperature setpoint Cooling mode Manual setting
P09	80	U	C06	C05	%	Fan speed setpoint comfort setting
P10	60	U	C06	C05	%	Fan speed setpoint economy setting
P11	40	U	C06	C05	%	Fan speed setpoint night setting
P12	80	U	C06	C05	%	Fan speed setpoint manual setting
P13	100	U	C06	C05	%	Fan speed setpoint digital input setting
P14	40	U	C08	C07	%	Damper opening setpoint comfort setting
P15	30	U	C08	C07	%	Damper opening setpoint economy setting
P16	20	U	C08	C07	%	Damper opening setpoint night setting
P17	40	U	C08	C07	%	Damper opening setpoint manual setting
<b>CNF</b>						<b>Configuration Parameters</b>
C01	30.0	S	P01	100.0	°C-°F	Maximum Temperature Setpoint Value in Heating Mode
C02	10.0	S	0.0	P01	°C-°F	Minimum Temperature Setpoint Value in Heating Mode
C03	30.0	S	P02	100.0	°C-°F	Maximum Temperature Setpoint Value in Cooling Mode
C04	10.0	S	-10.0	P02	°C-°F	Minimum Temperature Setpoint Value in Cooling Mode
C05	100	S	C06	100	%	Maximum Fan Setpoint Value
C06	10	S	0	C05	%	Minimum Fan Setpoint Value
C07	100	S	C08	100	%	Maximum damper setpoint value
C08	10	S	0	C07	%	Minimum damper setpoint value
C09	1	M	0	1		Enable RTC 0: OFF 1: ON
C10	0	M	-32,768	32,767		Parameter unused
C11	1	S	0	2		Changeover mode 0: Manual 1: Manual + Automatic 2: Auto
C12	5	M	1	100	%	Fan/damper control step
C13	10	M	1	255	s	Increase/decrease fan/damper control time
C14	20	M	C06	C05	%	Minimum fan value with compressor ON
C15	20	M	C06	C05	%	Minimum fan value with 1 heater ON
C16	30	M	C06	C05	%	Minimum fan value with 2 heaters ON
C17	30	M	0	255	s	Post-ventilation from OFF
C18	-12	S	-127	127		Servicer password
C19	-123	M	-127	127		Manufacturer password

Label	Default value	Default visibility	Min	Max	um	Description
C20	2	S	0	5		Second display 0: Time 1: Humidity 2: Temperature setpoint 3: External temperature 4: Fan speed 5: Fan pressure capacity/differential
C21	0	S	0	1		Sun LED meaning 0: Heating 1: Cooling
C22	1	S	1	247		MODBUS serial address
C23	0	S	0	1		Changeover type configuration 0: Room Temperature 1: External temperature
C24	8	S	0	255	h	Operating Mode Changeover Delay
C25	20.0	S	-10.0	100.0	°C-°F	Temperature for change to heating mode
C26	26.0	S	-10.0	100.0	°C-°F	Temperature for change to cooling mode
C27	0	M	0	2		Type of recovery heat exchanger 0: Cross-flow 1: Rotary 2: Thermodynamic
C28	12	M	0	255	s*10	Minimum compressor off time
C29	36	M	0	255	s*10	Minimum time between compressor switch-ons
C30	2	M	0	2		First coil type 0: Cooling 1: Heating 2: Reversible
C31	20	M	0	100	s	Heater activation period in PWM
C32	10.0	M	0.0	10.0	V	PWM output voltage active
C33	90	M	0	255	s	Three-point Water Valve 1 Running Time
C34	20	M	1	100		Maximum Number of three-point Water Valve Closures for Re-synchronisation
C35	0	M	-100	100	%	Difference between Supply and Suction
C36	0	M	0	255	s	Fan OFF time for bypass damper
C37	2.0	S	0.0	25.5	°C-°F	Regulation Band in Heating Mode
C38	2.0	S	0.0	25.5	°C-°F	Regulation Band in Cooling Mode
C39	5	M	1	100	%	Heat regulation control step
C40	30	M	1	255	s	Heat regulation increase/decrease time
C41	2.0	M	0.0	25.5	°C-°F	Room temperature delta for follow-on regulation in Heating mode
C42	2.0	M	0.0	25.5	°C-°F	Room temperature delta for follow-on regulation in Cooling mode
C43	5.0	M	0.0	25.5	°C-°F	Room Setpoint delta for follow-on regulation in Heating mode
C44	5.0	M	0.0	25.5	°C-°F	Room Setpoint delta for follow-on regulation in Cooling mode
C45	3	M	0	3		Dehumidifying mode 0: OFF 1: Heating 2: Cooling 3: Heating/Cooling
C46	50	U	1	100	%	Humidity setpoint



Label	Default value	Default visibility	Min	Max	um	Description
C47	5	S	0	255	%	Humidity regulation band
C48	1	M	0	1		Dehumidifying in cooling mode with priority over heat regulation 0: OFF 1: ON
C49	25	M	0	255	°C-°F	Minimum humidifier supply temperature value
C50	1,000	S	0	5,000	ppm	CO <sub>2</sub> over-modulation setpoint
C51	100	S	0	5,000	ppm	CO <sub>2</sub> over-modulation band
C52	5	M	0	255	°C-°F	Free-heating temperature differential setpoint
C53	5	M	0	255	°C-°F	Free-cooling temperature differential setpoint
C54	1.0	M	0.0	25.5	°C-°F	Free cooling/heating hysteresis
C55	5.0	M	0.0	25.5	°C-°F	Off-band setpoint
C56	1,000	S	-5,000	5,000	Pa-m3/h	Control setpoint in constant pressure/flow
C57	50	S	0	5,000	Pa-m3/h	Control band in constant pressure/flow
C58	0	S	0	1,000		Flow-rate coefficient 0: Control in constant pressure
C59	0	S	0	1		Temperature Measurement Unit 0: Celsius (°C) 1: Fahrenheit (°F)
C60	0	M	0	1		Enable external air limitation function 0: OFF 1: ON
C61	2	S	0	3		MODBUS baud rate 0: 2400 1: 4800 2: 9600 3: 19200
C62	2	S	0	2		MODBUS parity 0: None 1: Odd 2: Even
C63	0	S	0	1		MODBUS stop bits 0: 1 stop bit 1: 2 stop bit
C64	90	M	0	255	s	Three-point Water Valve 2 Running Time
C65	1.0	S	-10.0	100.0	°C-°F	Pre-heating start setpoint
C66	1.0	S	0.0	25.5	°C-°F	Pre-heating regulation band
C67	20	S	0	255	s*10	Maximum Pre-heating time
C68	1	M	0	1		Fire/smoke alarm regulation type 0: Fire 1: Smoke
<b>DEF</b>						<b>Defrosting parameters</b>
d01	0	M	0	3		Refrigeration circuit defrost mode 0: OFF 1: ON 2: with compressor switched off 3: timed
d02	-5.0	M	-10.0	100.0	°C-°F	Refrigeration circuit defrost start setpoint
d03	20	M	0	255	min	Refrigeration circuit defrost activation delay
d04	15.0	M	-10.0	100.0	°C-°F	Refrigeration circuit defrost end setpoint
d05	5	M	1	255	min	Maximum refrigeration circuit defrost time
d06	60	M	0	255	s	Refrigeration circuit compressor/reversing valve waiting time

Label	Default value	Default visibility	Min	Max	um	Description
d07	6	M	0	255	s*10	Refrigeration circuit drip time
d08	-20.0	M	-10.0	100.0	°C-°F	Refrigeration circuit forced defrost start setpoint
d09	5.0	M	-10.0	100.0	°C-°F	Recovery heat exchanger defrost start setpoint
d10	2.0	M	0.0	25.5	°C-°F	Recovery heat exchanger defrost regulation band
d11	10.0	M	-10.0	100.0	°C-°F	Recovery heat exchanger stop setpoint in defrost
d12	20	M	0	255	%	Maximum difference between supply and return in recovery heat exchanger defrosting
d13	0	M	0	255		Rotary recovery heat exchanger turn time
<b>ALM</b>						<b>Alarm Parameters</b>
A01	10,000	M	0	10,000	h*10	Maximum fan hour limit 0: Disabled
A02	10,000	M	0	10,000	h*10	Maximum Compressor Hour Limit 0: Disabled
A03	0	M	0	255	s	Fan alarm bypass time
A04	120	M	0	255	s	Low pressure alarm bypass time
A05	3	M	0	255		Number of low pressure and valve alarm signals per hour
A06	30	M	0	255	s	Flow switch alarm bypass time
A07	10	M	0	255	s	Flow switch alarm delay from flow switch input activation
A08	10	M	0	255	s	Flow switch alarm reset delay from flow switch input deactivation
A09	3	M	0	255		Number of flow switch alarms per hour
A10	60	M	0	255	s	External air damper running time
A11	105	M	0	255	°C-°F	High discharge temperature setpoint
A12	15.0	M	0.0	25.5	°C-°F	High discharge temperature alarm hysteresis
A13	60	M	0	255	s	Water temperature congruence alarm time
A14	60	M	0	255	s	Antifreeze alarm bypass time
A15	5	M	-127	127	°C-°F	Antifreeze Alarm Setpoint
A16	2.0	M	0.0	25.5	°C-°F	Antifreeze Alarm Hysteresis
<b>I-O</b>						<b>I/O Configuration Parameters</b>
I01	100	M	-19	113		IN1 input function configuration
I02	101	M	-19	113		IN2 input function configuration
I03	102	M	-19	107		IN3 input function configuration
I04	103	M	-19	107		IN4 input function configuration
I05	104	M	-19	107		IN5 input function configuration
I06	16	M	-19	107		IN6 (EV3)/IN10 (EVD) input function configuration
I07	9	M	-19	107		IN7 (EV3)/IN9 (EVD) input function configuration
I08	22	M	-19	23		IN8 input function configuration
I09	23	M	-19	23		IN9 (EV3)/IN7 (EVD) input function configuration
I10	8	M	-19	19		IN10 (EV3)/IN6 (EVD) input function configuration
I11	0	M	0	1		Humidity probe on display 0: OFF 1: ON
I12	0	M	0	1		Room temperature probe on display OFF 1: ON
I13	0	M	0	3		IN1 input type configuration 0 = NTC/Digital input 1 = 4-20 mA 2 = 0-10 V 3 = 0-5 V

Label	Default value	Default visibility	Min	Max	um	Description
I14	0	M	0	3		IN2 input type configuration 0 = NTC/Digital input 1 = 4-20 mA 2 = 0-10 V 3 = 0-5 V
I15	0	H	0	100	%	Start of humidity probe/remote control scale [@4mA/0V]
I16	100	M	0	100	%	End of humidity probe/remote control scale [@20mA/10V]
I17	0	M	-1,000	11,000	ppm-Pa	Start of CO <sub>2</sub> probe/pressure scale [@4mA/0V]
I18	2000	M	-1,000	11,000	ppm-Pa	End of CO <sub>2</sub> probe/pressure scale [@20mA/10V]
I19	0.0	M	-12.7	12.7	°C-°F-%-ppm-Pa	IN1 Analogue Input Offset
I20	0.0	M	-12.7	12.7	°C-°F-%-ppm-Pa	IN2 Analogue Input Offset
I21	0.0	M	-12.7	12.7	°C-°F	IN3 Analogue Input Offset
I22	0.0	M	-12.7	12.7	°C-°F	IN4 Analogue Input Offset
I23	0.0	M	-12.7	12.7	°C-°F	IN5 Analogue Input Offset
I24	0.0	M	-12.7	12.7	°C-°F	IN6 (EV3)/IN10 (EVD) analogue input offset
I25	0.0	M	-12.7	12.7	°C-°F	IN7 (EV3)/IN9 (EVD) analogue input offset
I26	5	M	-15	15		DO1 digital output function configuration
I27	6	M	-15	15		DO2 digital output function configuration
I28	12	M	-15	15		DO3 digital output function configuration
I29	7	M	-15	15		DO4 digital output function configuration
I30	0	M	-15	15		TK1 (EV3)/OC (EVD) digital output function configuration
I31	0	M	-15	15		TK2 digital output function configuration
I32	0	M	-15	15		AO1 digital output function configuration
I33	0	M	-15	15		AO2 digital output function configuration
I34	3	M	0	5		AO1 analogue output function configuration
I35	4	M	0	5		AO2 analogue output function configuration
I36	0	M	0	1		TK1 (EV3)/OC (EVD) analogue output function configuration
I37	0	M	0	1		TK2 analogue output function configuration
I38	2	M	0	4		AO1 analogue output type configuration
I39	2	M	0	4		AO2 analogue output type configuration
I40	100	M	1	200	Hz*10	PWM Output Frequency

## 8.2 Configuring inputs

All the inputs can be configured by entering the appropriate values into parameters I01-I10. To configure a digital input, enter a value less than 100; to configure an analogue input, enter a value equal to or greater than 100.

The value 0 indicates that no function is associated with the input.

All 10 inputs can be used as digital inputs, but only some (IN1, IN2, IN3, IN4, IN5, IN6 and IN7 on EV3 MVC; IN1, IN2, IN3, IN4, IN5, IN9 and IN10 on EVD MVC) can be configured as analogue inputs.

Inputs IN1 and IN2 are universal, configurable through parameters I13 and I14, whereas the other analogue inputs are NTC/digital inputs.

To configure a digital input, you must assign a number to the corresponding parameter consisting of an absolute value that indicates the function and a sign that indicates the polarity:

Negative= Normally closed (NC)

Positive= Normally open (NO)



If an unexpected value (see table) is set in parameters I01-I10, the value will not be rejected by the controller, but no function will be assigned to the input. If two or more inputs are configured with the same value, only the input with the highest index will be used. For example, if both IN4 and IN6 are configured for a room probe, the value associated with input IN4 will be ignored and only the value associated with input IN6 will be used.

### 8.2.1 Configuring input functions

Parameter value I01 - I10	Description
0	Disabled
1	Supply fan thermal switch
2	Return fan thermal switch
3	Supply flow switch
4	Return flow switch
5	High pressure
6	Low pressure
7	Compressor thermal switch
8	Remote ON-OFF
9	Operating mode changeover
10	Coil water antifreeze
11	Heater thermal switch
12	Thermostat request
13	Dehumidifier request
14	External air damper open limit switch
15	External air damper closed limit switch
16	Forced ventilation
17	Dirt filters
18	Heat pump status
19	Fire alarm
20	unused
21	unused
22	Supply fan tachometer
23	Return fan tachometer
100	Room probe
101	Supply probe
102	External probe
103	Discharge probe
104	Water probe 1
106	Compressor defrost probe
107	Compressor discharge temperature probe
108	unused
109	unused

110	Humidity probe
111	CO <sub>2</sub> probe
112	Remote control probe
113	Pressure differential probe

### 8.2.2 Universal input type configuration

Parameter value I13/I14	Description
0	NTC / Digital input
1	4-20 mA
2	0-10 V
3	0-5 V

**Important:** only for EV3 MVC, if either input IN1 or IN2 has been set to powered up (0-5 V or 0-10 V), the other must be also. If this does not happen the reading of the input set to powered up will be affected by the offset.

The choice of the type of probe influences the unit of measurement used: probes measuring temperature return values in °C or °F depending on the setting of parameter C59, while probes measuring power or voltage use the units Pa or % (%rh in EVJ LCD) in accordance with the conversion scales set by parameters I15-I18 that determine the scale start and end values for sensors configured as humidity, CO<sub>2</sub>, pressure or remote control probes.

### 8.3 Analogue Output Configuration

There are 2 analogue outputs, AO1 and AO2. Parameters I38 and I39 determine the output type: 0-10 V, phase cutting, PWM, frequency or disabled.

#### 8.3.1 Configuring type AO

Parameter value I38 - I39	Description
0	Disabled (or DO)
1	Phase cutting
2	0-10 V
3	PWM
4	Frequency

The choice of the output type influences the unit of measurement: frequency outputs are measured in Hz whereas phase cutting, power and PWM outputs are measured in %.

If the heaters are driven by a solid-state relay, low-frequency PWM and live voltage can also be regulated and can be configured (between 0 and 10 V) by parameter.

The timing of the resulting square wave (from 0 to 255 seconds) can be configured by parameter C31, while the amplitude of the output signal is configured by parameter C32. In order to use this regulation, the output must be configured as 0-10 V. If a heater is driven by a modulating signal of 0-10 V, parameter C31 is to be set to 0.

##### 8.3.1.1 Disabled (or DO)

If it is decided to disable the analogue output it can be used as a DO digital output.

##### 8.3.1.2 Phase cutting (with AC power only)

A pulse of 500 µs is generated at the output, synchronised with the 0 of the device's power supply voltage. The pulse delay relative to the zero-crossing is calculated so that the value set is the value of the effective voltage on the load: below 20% the output is always off, above 90% the output is always on.

A fixed start-up time of 1s is applied when the output shifts from 0% to a different value: for this time the output is forced at 100%.

The shift value is fixed at 2.5 ms.

**8.3.1.3 0-10 V**

The output voltage varies according to the value set: 0% output always off, 100% output at 10 V.

**8.3.1.4 PWM**

A signal with constant frequency and variable duty cycle is generated at the output.

The frequency of the output configured as PWM is determined by the I40 parameter.

The duty cycle varies according to the value set: 0% output always off, 100% output always on.

**8.3.1.5 Frequency**

A signal with variable frequency and fixed duty cycle is generated at the output.

The output frequency varies according to the value set: below 10 Hz the output is always off. Maximum frequency value is 255 Hz. The duty cycle is always 50%.

**8.3.2 Exclusions**

It is not permitted for one analogue output to be configured as 0-10 V and the other as PWM or as a frequency. The table below outlines the permitted (O) and prohibited (X) configurations.

I38\I39	0	1	2	3	4
0	O	O	O	O	O
1	O	O	O	O	O
2	O	O	O	X	X
3	O	O	X	O	X
4	O	O	X	X	X

**8.3.3 Configuring AO function**

Parameters I34 and I35 determine the function of the analogue outputs in accordance with the following table:

Parameter value I34 - I35	Description
0	Disabled
1	Water valve
2	Heater
3	Supply fan
4	Return fan
5	Mixing chamber damper

**8.4 Configuring triac and open collector outputs**

Model EV3 MVC has 2 triac outputs (with an optional board), while model EVD MVC has one (1) open collector output, which can be configured with parameters I36 and I37.

If it is decided to disable the triac/OC outputs they can be used as DO digital outputs.

Triac/OC outputs have % as the unit of measurement.

**TK/OC configuration**

Parameter value I36 - I37	Description
0	Disabled (or DO)
1	Heaters

In model EVD the TK1 triac output has been replaced with an open collector output.

## 8.5 Configuring digital outputs

The parameters between I26 and I33 configure the function associated with the digital outputs.

Both analogue and triac outputs can be configured as digital outputs if disabled as analogue outputs as previously explained.

As with the digital inputs, the parameters configuring the function assigned to each digital output consist of an absolute value indicating the function and a sign showing its polarity:

Negative = Normally closed (NC)

Positive = Normally open (NO)

The value 0 indicates that no function is associated with the digital output.

### Configuring DO

Absolute value of parameters I26 - I33	Description
0	Disabled
1	Supply fan
2	Return fan
3	Compressor
4	Reversing valve
5	Recovery heat exchanger/bypass damper
6	External air damper
7	Open water valve
8	Close water valve
9	Step 1 heater
10	Step 2 heater
11	Humidifier
12	Alarm

## 9 SERIAL PORTS

Controllers EV3 MVC and EVD MVC have the following serial ports:

- INTRABUS baud rate 19,200, even, 1 stop bit
  - proprietary communications protocol INTRABUS node 1 (MASTER)
- RS-485 baud rate from parameter C61 (default 9600)
  - even from parameter C62 (default even)
  - stop bit from parameter C63 (default 1)
  - MODBUS SLAVE communications protocol node from parameter C22 (default=1).

The MODBUS RS-485 serial port can be used to communicate with a supervision system or a personal computer.

The document "MODBUS IMPLEMENTATION TABLE" (document code 1463DMVC104) describes the resources of the devices accessible via the RS-485 serial port. The document is available on the [www.evco.it](http://www.evco.it) website.

The INTRABUS serial port enables a remote keypad (EVK3K11 or EVJ LCD) to be connected to the EV3 or the EVD MVC controller.



## 10 FUNCTIONING OF THE CONTROLLER

### 10.1 Regulation in the incremental neutral zone

The working parameters for regulation in the neutral zone consist of a setpoint, a regulation band, a reaction time and an incremental step. Almost all the available functions use these regulating mechanisms.

Because this system is extremely easy and intuitive to operate it provides excellent results, allowing precise regulation.

The neutral zone is between the setpoint:

- 1) When the variable being controlled is within the neutral zone, the regulation does not amend the corresponding output value.
- 2a) When the regulation variable falls below the neutral zone, the regulation immediately increases the controlled output value by a percentage equal to the value expressed by the relevant parameter (incremental/decremental regulation step)
- 2b) If the regulation variable is not within the neutral zone by the time set by the parameter "reaction time", point 2a above is repeated until the maximum possible value of the output value is reached.
- 3) The regulation procedure is inversed when the variable being controlled rises above the neutral zone.

The diagram below is a graphic representation of the operating mode.

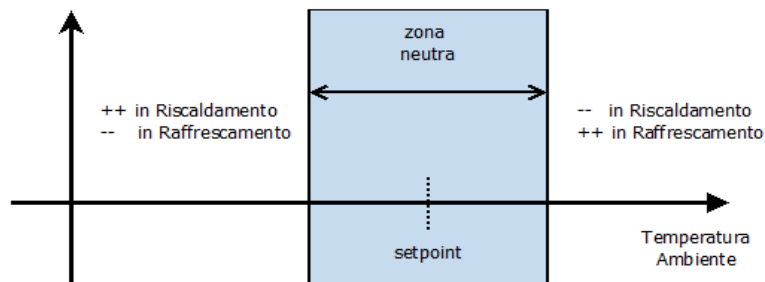

### 10.2 Activating free heating/cooling

This mode is activated if the *room probe* and *external probe* are activated and not in alarm.

If the external temperature is favourable this inhibits the recovery heat exchanger (bypass or deactivation) so as to use the external air to improve the room comfort.

If the controller detects favourable conditions with a differential between the external and internal temperatures capable of cooling or heating the room, the recovery heat exchanger bypass is activated (bypass damper activated, rotation of the rotary exchanger deactivated, compressor switched off) and the mixing chamber damper is fully opened.

Activation of these functions naturally leads to the room temperature coming close to the relevant setpoint thus requiring no further forced regulating action. The two functions are therefore completely independent.

#### 10.2.1 Summer mode (free-cooling)

When the temperature rises above the regulation setpoint, thus requiring cooling, and when the conditions shown in the diagram below apply, the recovery heat exchanger bypass is activated (bypass damper activated, rotation of the rotary exchanger deactivated, compressor switched off).

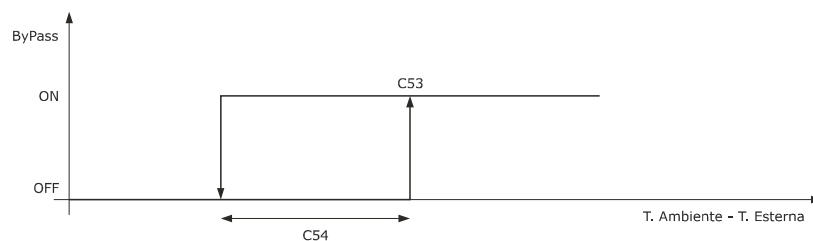

#### 10.2.2 Winter mode (free-heating)

When the temperature falls below the regulation setpoint, thus requiring heating, and when the conditions shown in the diagram below apply, the recovery heat exchanger bypass is activated (bypass damper activated, rotation of the rotary exchanger deactivated, compressor switched off).

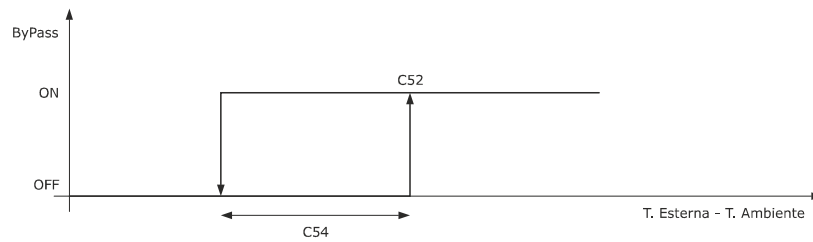

### 10.3 Regulating the ventilation

The controller manages two fans: the supply fan and the return fan. The regulation of both fans is driven by an analogue output that can be single (the same speed for both fans) or independent. It is also possible to configure an enabling digital output, either single or independent. The enabling digital output is activated when the relevant analogue output is set to a value other than 0.

Both fans are regulated in the same way and the point of reference is the supply fan. It is however possible to differentiate the supply and return fan speeds in order to balance the different losses of load in the tubes or to keep the room at low/high pressure by configuring parameter C35 that sets the differential between the speed of the two fans.

The return fan is switched off if the supply fan is off.

Post-ventilation can be set at a duration of C17 from when the unit is switched off to ensure the disposal and recovery of the residual heat from the coils.

Regulation of the fans follows the order of priority below:

- If a defrost of the recovery heat exchanger is in progress the fans follow the algorithm described in the relevant paragraph, while if a defrost of the refrigeration unit is active the fans are switched off unless defrost happens because the compressor is switched off (in which case ventilation operates normally).
- External air limitation regulation, when the fans are involved.
- If the digital input *forced ventilation* is configured and active, the supply fan speed is determined by parameter P13.
- If the pressure differential sensor is configured and not in alarm mode, regulation is based on this sensor following the algorithm in constant flow-rate or pressure as described in the relevant paragraphs.
- If the *remote control probe* is configured and not in alarm mode, the fan speed is the same as that of the probe as set by parameters I15 and I16, which define the value of the output relative to the minimum and maximum value respectively of the input.
- If the CO<sub>2</sub> sensor is configured and not in alarm mode, regulation is based on this sensor as described in the relevant paragraphs.
- If the humidifier in heating (C45) is enabled and the *humidity* sensor is configured and not in alarm mode, or if the *dehumidifier request* digital input is configured and active, regulation is based on the value of the aforesaid inputs as described in the relevant paragraph.
- If none of these situations exists, the fan speed is determined by the current setpoint (manual or time bands).

All the ventilation regulations with the exception of remote control, use a fixed incremental step set by parameter C12, at the intervals defined by parameter C13.

The fan speed is always limited by the minimum (C05) and maximum (C06) values, also taking into account any forced ventilation supporting the refrigeration circuit (C14) and the electric coils (C15, C16) that are able to increase the minimum fan speed when such functions are activated.

During the active defrost phases of the refrigeration unit, the fans are switched off to keep any heat localised on the coil that does the defrosting and avoid an inflow of cold air and pressure imbalances in the room.

If the mixing chamber damper is completely closed, the return fan is switched off to avoid possible imbalances.

Parameter C36 sets the time the fans are switched off after the bypass damper has changed its position.

#### 10.3.1 External air damper

When the digital output *external air damper* is configured fan switch-on is dependent on the opening of the damper: from the moment when the damper is opened, the open time A10 must elapse before the fans are switched on.

If the digital input *External air damper open limit switch* is configured, the fans remain off until the damper halts contact.

When the fans are switched off the external air damper is also closed.

### 10.4 Regulating the recovery heat exchanger

The controller can manage 3 different types of recovery heat exchanger, configured using parameter C27:

- Cross-flow
- Rotary
- Thermodynamic (compressor).

In order to use this function, the *recovery heat exchanger/bypass damper* or *Compressor* (if the recovery heat exchanger is thermodynamic) relay must be configured. Cross-flow recovery heat exchanger is a passive system, meaning that when activated the corresponding relay is in rest position. When the recovery heat exchanger is inactive the corresponding relay opens the bypass damper. Rotary and thermodynamic recovery heat exchangers are active systems meaning that the corresponding relay must be active for the exchanger to operate.

Irrespective of the type, the recovery heat exchanger is always operating other than in the following situations when it is deactivated:

- If the fans are in alarm mode or the machine in standby mode (only in the case of active recovery heat exchanger since the energy exchange would be nil while there would be energy consumption required to keep the exchanger active)
- If the mixing chamber damper is completely closed for the same reason as above (in this case the return fan is switched off)
- If the free heating or free cooling functions are activated.

If the expulsion temperature falls below the critical value  $d11$ , the rotary recovery heat exchanger stops or the bypass damper for the cross-flow recovery heat exchanger opens. Normal operation is restored when the expulsion temperature rises above the threshold  $(d11 + d10/2)$ .

#### 10.4.1 Defrosting cross-flow or rotary recovery heat exchanger

During the winter cycle, the recovery heat exchanger exchanges heat between the flow of expelled air (hot and humid) and the input air (cold and dry). If the external air is particularly cold, the expelled air flow temperature can fall to freezing point, risking obstruction of the exchanger and impeding normal air flow.

To prevent this happening, the expelled air flow temperature should be prevented from falling excessively by constantly monitoring it and, when needed, first slowing down just the supply fan and then both fans.

Adjustment takes place on the temperature of the *expulsion probe* in the neutral zone with setpoint  $d09$ , band  $d10$ , step  $C12$  and time  $C13$ : if the temperature is too low ( $<d09 - d10/2$ ) the speed of the supply fan is reduced relative to that of the return fan up to a maximum differential ( $d12$ ) always taking into account any balancing of the  $C35$  speeds which is always valid; if the need for defrosting persists, the speed of both fans will be reduced in parallel down to the minimum permitted speed ( $C06$ ). If, however, the expulsion temperature falls below the critical value  $d11$ , the rotary recovery heat exchanger stops or the bypass damper for the cross-flow recovery heat exchanger opens.

The fan speeds gradually return to their normal value when the expelled air temperature rises above the value of  $d09+d10/2$ .

Regardless of the fan speed regulation settings these are suspended while defrosting is in progress. When defrosting is finished, the fan speed regulation returns to the normal settings.

In the event of manual regulation, it is possible to set a different value for the fan speeds, but this value will only be valid when defrosting is finished.

### 10.5 Regulating the mixing chamber damper

When present, the mixing chamber damper regulates the quantity of recirculated air and external air emitted into the room (damper completely closed = all recirculated; damper completely open = all external air).

The percentage of damper opening therefore influences the following factors:

- Temperature (free cooling/heating and off band)
- Humidity (winter dehumidifier)
- $CO_2$ .

The controller regulates the opening of the mixing chamber damper using the modulating 0-10 V output; to activate the function the *Mixing chamber damper* analogue output should be configured.

This regulation works with that of the fans both in terms of the percentage increase/decrease ( $C12$ ) and the relative timing ( $C13$ ).

In normal conditions the damper is open by at least the minimum opening percentage ( $C08$ ) to guarantee the minimum air exchange in the room.

There are some conditions in which the minimum opening setting is not applied (damper completely closed):

- If the machine is in stand-by
- If the regulation temperature is "off-band"
- If the fans are in alarm mode.

If the free cooling or free heating functions are activated, the mixing chamber damper is completely open.

In all other situations the damper opening depends on the configuration of the machine in the following order of priority:

- If the  $CO_2$  sensor is configured and not in alarm mode, the damper opening depends on the value detected by this probe as described in the relevant paragraph.
- If the humidity sensor is configured and not in alarm mode, the "heating" function activated and the winter dehumidifier enabled, the damper opening depends on the value detected by this probe as described in the relevant paragraph.

- If none of the above situations apply, the damper opening is determined by the regulation setpoint (P14...P17) associated with the time band in progress.

## 10.6 Temperature regulation

The temperature regulation algorithm is of the "incremental neutral zone" type previously described. The temperature used for regulation can be the room temperature or the supply temperature if only one of these probes is configured. If neither of the probes is configured or if they are in error, temperature regulation is inhibited.

If a 3 point valve is configured, the temperature regulation is "frozen" when it is in motion so as to maintain control of the position of the valve.

If both the probes (room and supply) are configured, the regulation probe is the supply temperature but the setpoint is adjusted to the room temperature (follow-on regulation) as shown in the diagram below.

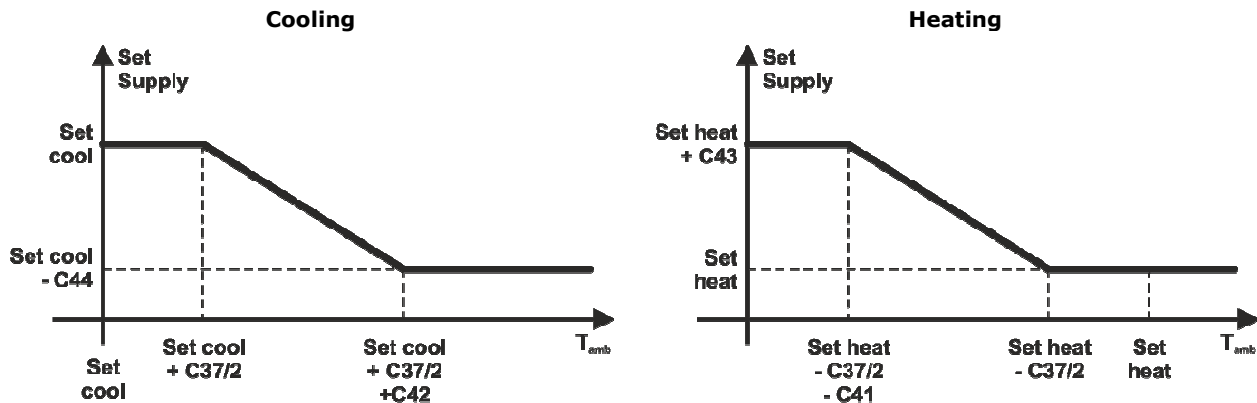

### 10.6.1 Treatment coils

The controller is able to manage one or two coils for heating and cooling of the air emitted into the room. The purpose of these coils, together with the recovery heat exchanger, is to guarantee that the ideal temperature is maintained in the air-conditioned environment.

The first coil can be hot, cold or reversible according to parameter C30. The second coil can only be hot and can be used as:

- The single heating source (in the winter cycle) if the first coil is cold only and as post-heating in the summer cycle
- The second heating level (in the winter cycle) if the first coil is hot or reversible, always as post-heating in the summer cycle if the first coil is reversible (if the first coil is hot dehumidifying is not possible and therefore post-heating does not apply).

The coils are allocated according to the resources used.

If the first coil is not configured, then neither is the second.

The types of coils managed are as follows:

- Direct expansion coil: can be hot, cold or reversible depending on parameter C30. It uses the *Compressor* relay
- Three-point water coil: can be hot, cold or reversible depending on parameter C30. It uses the *Open water valve* and *Close water valve* relays. The duration of the valve action is determined by parameter C33.
- Water coil ON-OFF: can be hot, cold or reversible depending on parameter C30. It uses the *Open water valve* relay.
- Modulating water coil: can be hot, cold or reversible depending on parameter C30. It uses the *Water valve* analogue output configured as analogue output 0-10 V and the *Open water valve* relay to enable (optional)
- One or two step electric coil: can only be hot. It uses the *Step 1 heater* and *the Step 2 heater* relays
- Modulating electric coil: can only be hot. It uses the *Electric heater* analogue output configured as analogue output 0-10 V or a triac/OC output configured as *Electric heater*. The *Step 1 heater* is used to enable. If parameter C31 (electric heater activation period) is greater than 0, the analogue output is controlled in PWM with a period of C31 seconds and with the maximum output signal amplitude determined by parameter C32. For example, if C31=10 seconds, C32=8 V and regulation with 50% regulation, the output signal takes on the value 8 V for 5 seconds and the value 0 V for another 5 seconds. If however, C31=0 the output is modulating (where the output voltage corresponds to the percentage of heat regulation required).

N.B. The electric and direct expansion coils are only switched on when the time A06 (flow alarm bypass) has elapsed from when the fans are switched on, to guarantee airflow and avoid any possible overheating problems.

### 10.6.2 Winter pre-heating (Hot Start)

This function prevents the entry of excessively cold air into the room. On start-up, before the fans are switched on the hot water coil is fully activated for a period calculated on the basis of the external temperature, keeping the external air damper closed and the mixing chamber damper fully recirculating.

In no instance is the valve running time taken into consideration.

At the end of the pre-heating the temperature regulation is activated (first opening the external air damper and then the fans) starting from the current state. If only the second coil is a water coil (the first coil therefore being thermodynamic) the water coil is turned off and the heat regulation starts immediately to operate from a situation in which both batteries are turned off.

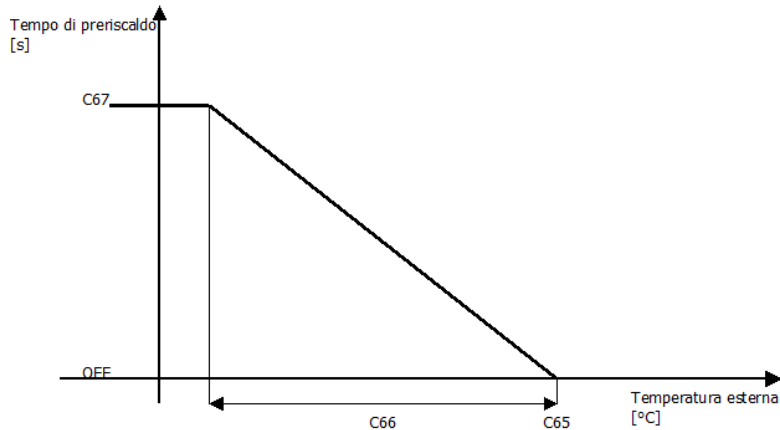

### 10.6.3 Off-band mode activation

This function is activated if the room probe is configured and not in alarm mode and if the mixing chamber damper is configured.

The room temperature is considered off-band if it is outside the comfort zone ( $T_a < \text{Heating setpoint} - \text{Comfort band (C55)}$  in heating mode;  $T_a > \text{Cooling setpoint} + \text{Comfort band (C55)}$  in cooling mode).

The effect of the off-band mode is to close the mixing chamber damper (at the same time turning off the extractor fan) so as to speed up the return of the regulation temperature into the band.

The mode is deactivated if the room temperature comes close to the active regulation setpoint returning within the normal active regulation band (C37 in heating, C38 in cooling) as shown in the diagrams.

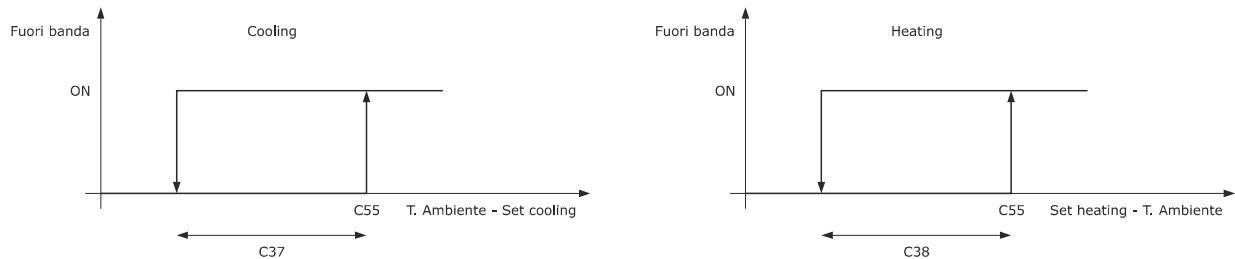

**N.B. If the FC/FH is enabled, the function is inhibited.**

### 10.7 Regulating the compressor

The controller can manage an ON-OFF compressor that can be used as either a first hot/cold/reversible regulation coil teamed with a cross-flow or rotary recovery heat exchanger or a thermodynamic recovery heat exchanger as an alternative to the other types of heat exchangers. As compared to the other types of coils and recovery heat exchangers, the safety features listed below should be taken into consideration for managing the compressor:

- Minimum time between switch-on (C29) and minimum switch-off time (C28)
- Safety inputs (high and low pressure, compressor thermal switch, discharge temperature, etc.).

In order for the compressor to function as a thermodynamic recovery heat exchanger (active in both heating and cooling mode) or as a reversible coil, an *inversion valve* digital output must be configured to allow the refrigeration circuit to function in both operating modes.

When the mode is changed (from heating to cooling or vice versa) the compressor, if active, is switched off and the valve reversed.

Another feature of the compressor is the need for defrosting, which should be managed in such a way as to remove ice that has formed in the coil as described in the paragraph below.

During the active defrost phases the refrigeration circuit function is inverted. To retain the heat localised on the coil that needs defrosting and to avoid both pressure imbalances and emitting freezing air into the room, both fans are switched off.

N.B.: the compressor is only switched on when the time A06 (flow alarm bypass) has elapsed from when the fans are switched on to guarantee airflow and avoid any possible imbalances.

### 10.7.1 Defrosting the refrigeration circuit

In order to determine both when it is necessary to perform a defrosting cycle and to end this, the probe located on the coil (*Compressor defrost probe*) is used according to the parameters governing this function (d01-d08).

According to the parameter d01 value, defrosting can be:

d01 = 0 Defrost not enabled

d01 = 1 Defrost by temperature, described below

When the compressor is active and the value detected by the probe located on the coil falls below d02, a counter begins and when this reaches a value of d03 the defrost cycle is activated. If during counting the temperature returns to above d02 or if the compressor is switched off, the count is suspended. If during counting the temperature detected by the probe falls below the value d08 defrosting is activated with a wait reduced to 10 seconds.

When the defrost cycle starts up the compressor is switched off for the d06 time, at the end of which this switches the reversing valve. After a further d06 period the compressor is reactivated for the active defrost cycle phase. The purpose of the waiting time 2xd06 is to balance the pressures in the circuit (this could also be set to zero if a running defrost is required).

The compressor remains on until the temperature detected by the probe on the coil rises above d04, in which case the active phase comes to an end. If this condition is not achieved within the d05 time, the active defrost phase is in any case concluded by switching off the compressor. After this the drip phase begins, after d07 the reversing valve switches to heating status and after a further d07, the compressor is reactivated in heating mode.

The diagram below shows how defrosting by temperature takes place:

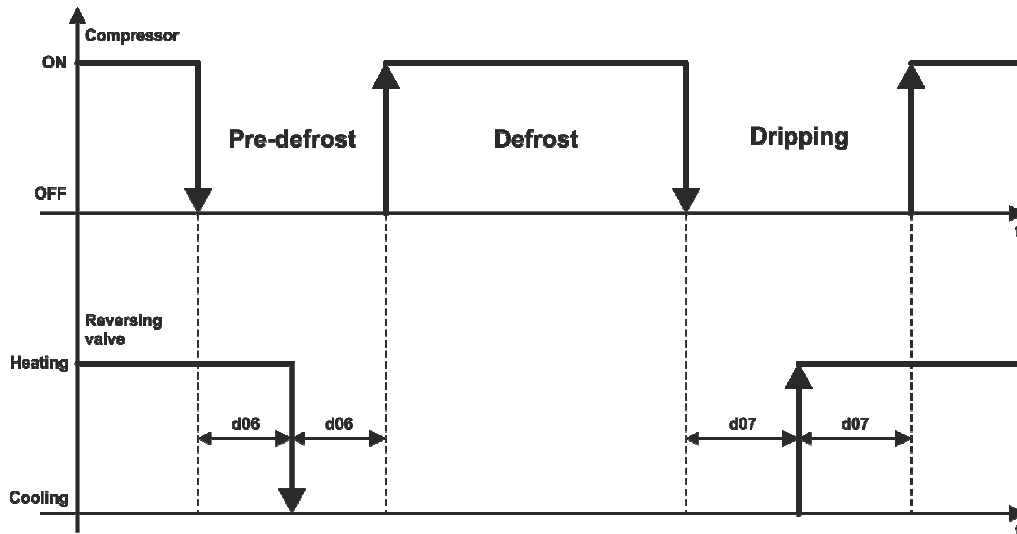

d01 = 2 Defrost by compressor off, described below

To defrost the coil the compressor is switched off, in which case the fans remain on and the warm expelled air removes the ice. Compared to the last process, this one avoids the active phase of the defrost cycle (compressor on with reversing valve in the cooling position)

d01 = 3 Defrost timed, described below

In this situation everything works as for d01=1 apart from the exit from the defrost active phase that is always determined by the maximum time (d05).

### 10.8 Constant capacity/pressure regulation

The controller can regulate the fan speed to maintain constant pressure or air capacity if the differential pressure sensor is configured and not in alarm mode.

On the basis of the parameter C58 (capacity coefficient) value the regulation will be by pressure (C58 = 0) or capacity (C58 > 0). In the first situation the value detected by the differential pressure probe will be the setpoint value (C56), while in the second situation it is the value of the capacity calculated using the formula:

$$Q = k\sqrt{\Delta P}$$

In the incremental neutral zone, regulation is based on the values of the parameters C56 (setpoint) and C57 (neutral zone) with an increase of the C12 speed when the pressure/capacity value falls below C56 - C57/2, and a reduction of the C12 speed when the pressure/capacity value rises above C56 + C57/2. In this situation too, the action may be repeated if the condition remains above C13.

## 10.9 CO<sub>2</sub> regulation

The controller is able to keep the CO<sub>2</sub> value in the room under control to guarantee maximum comfort. Regulation acts first on the mixing chamber damper (if present) and then on the fan speed if the CO<sub>2</sub> probe is configured and not in alarm mode.

CO<sub>2</sub> control uses incremental neutral zone regulation with parameters C50, C51, C12 and C13. If the CO<sub>2</sub> concentration is too high (above the C50 setpoint plus half the neutral zone C51) the mixing chamber damper is gradually opened wider starting from the normal open position (defined by its setpoint and the active time band) up to its maximum aperture (C07). If the situation does not return to normal when the damper is open to its maximum degree (or if the damper is not present) the fan speed gradually increases, starting from normal speed (as defined by the setpoint and the active time band) until it reaches maximum speed (C05). When the concentration of CO<sub>2</sub> falls below the setpoint less half the band, the reverse is carried out: the fan speed gradually reduces down to normal speed, then the damper returns to its normal aperture.

**N.B.: if both a differential pressure sensor and a CO<sub>2</sub> probe are configured, the damper regulates in accordance with the CO<sub>2</sub> while the fans adjust in accordance with the differential pressure/capacity.**

## 10.10 Humidity regulation

The controller is able to control the room humidity to guarantee maximum comfort both when the humidity needs to be reduced (dehumidifying) and when it needs to be increased (humidifying). The dehumidifying processes in the summer and winter cycles are different.

### 10.10.1 Winter dehumidification

For environments that are also humid in winter (swimming pools for example) it is possible to use the extremely low humidity of the external air to reduce the internal humidity. In this situation regulation takes place by acting on the mixing chamber damper and on the fan speed if the dehumidifier is enabled in heating mode (C45) and the *Humidity probe* is configured and not in alarm mode or the *Dehumidifier request* digital input is configured and active.

The humidity is regulated in the incremental neutral zone by parameters C46, C47, C12 and C13. If the humidity is too high (>C46+C47/2) the mixing chamber damper is gradually opened wider, starting from normal then up to maximum aperture. If the situation does not return to normal when the damper is open to its maximum degree, the fan speed gradually increases, starting from normal speed until it reaches maximum speed. When humidity falls below the setpoint less half the band (C46-C47/2), the reverse is carried out: the fan speed gradually reduces down to normal speed, then the damper returns to its normal aperture.

### 10.10.2 Summer dehumidification

In the summer cycle the external air cannot cause an effective reduction in the room humidity, making it necessary to use a cold coil possibly with post-heating of the air.

Regulation acts on the cooling resources if the dehumidifier is enabled in cooling mode (C45) and the *Humidity probe* is configured and not in alarm mode or the *Dehumidifier request* digital input is configured and active.

If required, the summer dehumidifier is activated when the humidity is greater than C46+C47/2 or the dehumidifier request digital input is active. The process stops when the humidity falls below C46-C47/2 or the digital input is deactivated.

The humidity is regulated in the incremental neutral zone by parameters C46, C47, C39 and C40 that activate the cooling resources according to the heat regulation timings and methods.

Following dehumidification the room temperature is liable to fall below the active regulation setpoint (which is the cooling setpoint for the time band in progress, possibly in follow-on if the return/room probe and the supply probe are present). If this happens and the second coil is present the post-heating function is activated with regulation in the incremental neutral zone. In this case, the hot coil power is increased (in accordance with parameters C39/C40) when the temperature falls by C37/2 (regulation band in heating mode) below the setpoint; the coil power is decreased if the temperature rises above the setpoint (without waiting for it to rise by C37/2 above that value).

If parameter C48 is set to 0 temperature regulation takes priority over dehumidifying; in this situation if the regulation temperature falls below the setpoint - band/2 the dehumidifier request is inhibited. This parameter can be used to limit excessive cooling caused by dehumidification, for example if a post-heating coil is not present.

### 10.10.3 Humidification

If the winter cycle is activated the relative humidity in the room is likely to be quite low. To guarantee comfort in these conditions too, the regulator is able to manage an ON-OFF humidifier, which is activated if the humidity percentage falls below the setpoint - band (C46 - C47), provided that a *Humidifier* digital output is configured and the *Humidity probe* is configured and not in alarm mode. The humidifier is switched off when the humidity rises above the setpoint C46.

If the *Supply probe* is also configured, the humidifier is switched off to avoid condensation, if the supply temperature falls below the C49 limit.

### 10.11 External air limitation

This regulation is active only if the *Supply probe* has been configured and the function is enabled (C60).

In both summer and winter cycles, if the external temperature is particularly extreme (very high in summer and very low in winter) it is possible for the regulation setpoint not to be reached even with the heating or cooling resources at their maximum power.

In this situation external air limitation comes into play and, by reducing the quantity of external air, it limits this problem.

This function helps to maintain the room temperature even in very difficult environmental conditions.

When the regulation temperature is outside the neutral zone with heating/cooling resources at 100%, the external air limitation function first closes the mixing chamber damper down to its minimum aperture (C07) and then reduces the fan speed down to the minimum speed (C06) using regulation in the incremental neutral zone with the usual parameters for the temperature regulation (C39/C40) in progress (heating or cooling).

If the temperature reaches the regulation setpoint, the regulation "is reversed" by first gradually resetting the fan speed to normal and then opening the damper to its normal aperture.

N.B.: this function will make use of whatever resources are installed on the machine. For example, for units without dampers, the heating/cooling power will first be maximized (depending on the active function) and then the fan speed will be reduced; for units without dampers or treatment coils, the speed of the fans will be controlled directly.

## 11 INTERNAL STATUS

Status table

specific values for the temperature probes:

3276.4: Disabled

-3276.8: Error

specific values for the pressure probes:

327.64: Disabled

-327.68: Error

Specific analogue output values

- 1: Disabled

Digital input and output values

- 1: Disabled

0: OFF

1: ON

Label	Visibility default	min	max	UM	description
<b>Status</b>					<b>Status</b>
S01	U	0	1		Unit status 0: ON 1: Stand-by 2: Stand-by from time band 3: Stand-by from DI
S02	U				Time bands 0: OFF 1: ON



Label	Visibility default	min	max	UM	description
S03	U				Alarm in progress 0: OFF 1: ON
S04	U				Operating mode 0: Disabled 1: OFF 2: Comfort 3: Economy 4: Night 5: Holiday: 6: Manual 7: Holiday with machine off 255: None
S05	S	0	100	%	Fan Regulation Setpoint
S06	S				Fan operating mode 0: Normal 1: Remote 2: CO2 3: Humidity 4: Forced by DI 5: OFF - External air damper awaited 6: Alarm 7: OFF 8: OFF from digital input (DI) 9: OFF from time band (TB) 10: External air limitation 11: Constant pressure 12: Constant capacity 13: OFF - Defrosting 14: ON - Defrosting 15: 15 = Post-ventilation
S07	U			%	Supply Fan Speed
S08	U			%	Return Fan Speed
S09	S	0	100	%	Mixing chamber damper regulation setpoint
S10	S				Mixing chamber damper operating mode 0: Disabled 1: Normal 2: CO2 3: Humidity 4: Free cooling/heating 5: OFF 6: External air limitation
S11	S			%	Mixing chamber damper aperture
S12	S				Recovery heat exchanger operating mode 0: Disabled 1: OFF 2: ON
S13	S			%	Recovery heat exchanger percentage
S14	S				Recovery heat exchanger defrost phase 0: Not in defrost 3: Defrosting 5: Dripping
S15	U	0	100	80 %rH	Humidity setpoint

Label	Visibility default	min	max	UM	description
S16	U				Temperature regulation mode 0: Cold 1: Hot 2: Auto+Cold 3: Auto+Hot
S17	S	0	2		Heating/Cooling mode setting 0: Cold 1: Hot 2: Auto
S18	U			°C-°F	Changeover probe value
S19	U			°C-°F	Room probe value
S20	U			°C-°F	External probe value
S21	U			°C-°F	Return air humidity probe value
<b>STem</b>					<b>Temperature regulation</b>
S22	U	-10.0	100.0	°C-°F	Temperature setpoint
S23	S				Temperature regulation type 0: Disabled 1: Follow-on regulation 2: Regulation on room temperature 3: Regulation on supply temperature 4: Forced by DI
S24	S			°C-°F	Regulation probe
S25	S			°C-°F	Temperature setpoint in use
S26	S				First coil type 0: Not available 1: Thermodynamic 2: 3-point, water 3: Modulating, water 4: ON-OFF, water 5: 2-step, electric 6: Modulating, electric 7: ON-OFF, electric 255: Not configured
S27	S				2nd coil type 0: Not available 1: --- 2: 3-point, water 3: Modulating, water 4: ON-OFF, water 5: 2-step, electric 6: Modulating, electric 7: ON-OFF, electric 255: Not configured
S28	S				Thermodynamic coil operating mode 0: OFF 1: ON
S29	S				Water coil 1 operating mode 0: OFF 1: ON
S30	S			%	Coil 1 valve opening
S31	S				Water coil 2 operating mode 0: OFF 1: ON
S32	S			%	Coil 2 valve opening

Label	Visibility default	min	max	UM	description
S33	S				Electric coil operating mode 0: OFF 1: Step 1 2: Step 2
S34	S			%	Electric coil percentage
<b>SCmp</b>					<b>Regulating the compressor</b>
S35	S				Steps in operation
S36	S				Defrost phase 0: Not in defrost 1: Defrost 1 input 2: Defrost 2 input 3: Defrosting 4: Defrost output 5: Pre-drip 6: Dripping
S37	S			s	Defrost time
S38	S			min	Delay between defrosts
S39	S			s*10	Safety time
S40	S				Compressor in alarm mode 0: OFF 1: ON
<b>Oth</b>					<b>Other</b>
S41	S	0	0	h*10	Compressor operating hours
S42	S	0	0	h*10	Fan Operating Hours
S43	S	0	0	h*10	Unit operating hours
S44	S				Expansion resources used
S45	M				Current level 0: Hidden 1: User 2: Installer 3: Manufacturer
S46	M	-127	127		Password

## 12 SIGNALS AND ALARMS

The alarm signals can be of the following types.

- Automatic: the alarm is reset automatically once the cause of the alarm has disappeared
- Manual: must be reset manually (before resetting the alarms manually, check that the cause of the alarm has been rectified and then switch the device off and on)
- With a number of signals per hour (resetting is automatic provided the signal counter has not exceeded the parameter specified in the description of each alarm, after which they must be reset manually; the hourly signal counter is incremented once every 225 seconds).

The table below shows the meaning of the device's various alarm codes.

Code	Label on display	Description
AL01	oFFd	Check switch-on by digital input Indicates that the controller is switched off and is being controlled remotely. Main results: - the loads are switched off with the preset timings
AL02	oFFt	Check switch-on by time band Indicates that controller is switched off by time band regulation. Main results: - the loads are switched off with the preset timings
AL03	EA	Cumulative probe alarm Indicates that one or more of the probes is in alarm mode. Non-configured analogue inputs do not cause alarms. Automatic alarm. Main results: - the functions linked to the probes in alarm mode are inhibited
AL04	ACoM	Communication alarm
AL05	AFro	Antifreeze alarm The alarm is activated when the value of one of the configured water probes is lower than the value A15 or if the <i>Coil Water Antifreeze</i> digital input is configured and active; it is deactivated when the value of all the configured water probes is higher than A15+A16 and the configured antifreeze digital input <i>is not active</i> . The alarm is delayed for a period equal to A14 from when the threshold temperature is reached or the digital input is activated. Automatic alarm. Main results: - the water valves are opened fully
AL06	Atr	Electric coil heater thermal switch alarm The alarm is activated if the input configured as a heater thermal switch input is active. It is deactivated if the input is inactive. Manual alarm. Main results: - the electric coil is switched off - the fans are running at maximum speed
AL07	AHP	High pressure alarm The alarm is activated if the input configured as a high pressure input is active. It is deactivated if the input is inactive. Manual alarm. Main results: - the compressor is switched off - the fans are running at maximum speed

Code	Label on display	Description
AL08	ALP	<p>Low pressure alarm</p> <p>The alarm is activated if the input configured as a low pressure input is active. It is deactivated if the input is inactive.</p> <p>The alarm is activated after a delay of A04 from compressor switch-on.</p> <p>It reverts to manual reset if the number of alarm events in an hour exceeds A05.</p> <p>Main results:</p> <ul style="list-style-type: none"> <li>- the compressor is switched off</li> <li>- the fans are running at maximum speed</li> </ul>
AL09 AL10	AFnS AFnr	<p>Supply or return fan alarm</p> <p>The alarm is activated if: - the input configured as fan thermal switch is active; - the input configured as fan tachometer does not receive feedback from the fan even though it is active with a minimum speed of 5%.</p> <p>The alarm is deactivated if: - the input configured as fan thermal switch is not active; - the input configured as fan tachometer receives feedback from the fan.</p> <p>The alarm is activated after a period equal to A03 from when the event occurs.</p> <p>Manual alarm.</p> <p>Main results:</p> <ul style="list-style-type: none"> <li>- all loads are switched off</li> </ul>
AL11	AtC	<p>Compressor thermal switch alarm</p> <p>The alarm is activated if the input configured as compressor thermal switch is active. It is deactivated if the input is inactive.</p> <p>Manual alarm.</p> <p>Main results:</p> <ul style="list-style-type: none"> <li>- the compressor is switched off</li> </ul>
AL12	AdS	<p>Compressor discharge high temperature alarm</p> <p>The alarm signal is activated if the value of the probe configured as compressor discharge rises above the A11 parameter value, and it is deactivated when this measurement falls below A11-A12.</p> <p>Automatic alarm.</p> <p>Main results</p> <ul style="list-style-type: none"> <li>- the compressor is switched off</li> </ul>
AL13	AFnH	<p>Fan hour alarm</p> <p>The alarm signal is activated if the fan hour value is above the limit set by parameter A01.</p> <p>The alarm switches off when the fan hours are reset on the menu.</p> <p>Automatic alarm.</p> <p>Main results:</p> <ul style="list-style-type: none"> <li>- signal only</li> </ul>
AL14	ACPH	<p>Compressor hour alarm</p> <p>The alarm signal is activated if the compressor hour value is above the limit set by parameter A02</p> <p>The alarm switches off when the compressor hours are reset on the menu.</p> <p>Automatic alarm.</p> <p>Main results:</p> <ul style="list-style-type: none"> <li>- signal only</li> </ul>
AL15	AOdM	<p>External air damper alarm.</p> <p>The alarm signal is activated when the limit switch sensors for the external air damper do not react quickly enough (A10) when movement is ordered.</p> <p>Manual alarm.</p> <p>Main results</p> <ul style="list-style-type: none"> <li>- all loads are switched off</li> </ul>

Code	Label on display	Description
AL16	Artc	<p>Clock alarm</p> <p>The alarm signal is activated when the clock shows an invalid date or is damaged and time band regulation is activated (t01).</p> <p>Automatic alarm.</p> <p>Main results:</p> <ul style="list-style-type: none"> <li>- regulating using the clock is not permitted</li> </ul>
AL17 AL18	AFLS AFLr	<p>Supply or return flow alarm</p> <p>The alarm signal is activated when the input configured as a flow switch (for either supply or return) is active for a time period equal to A07, with a delay of A06 from the switch-on of the associated fan; it is deactivated when the input is inactive for a time period equal to A08.</p> <p>It reverts to manual reset if the number of alarm events in an hour exceeds A09.</p> <p>Main results:</p> <ul style="list-style-type: none"> <li>- when the alarm is in automatic mode the electric coils and the compressor are switched off</li> <li>- when the alarm is in manual mode all the loads are switched off</li> </ul>
AL19	ACnf	<p>Changeover probe not configured alarm</p> <p>The alarm is activated if the changeover probe has not been configured correctly.</p> <p>Automatic alarm.</p> <p>Main results:</p> <ul style="list-style-type: none"> <li>- inhibits the automatic changeover operations</li> </ul>
AL20 AL22	AV1 AV2	<p>Water temperature congruence alarm</p> <p>The alarm signal is activated in heating (cooling) mode if the water probe temperature is lower (higher) than the temperature setpoint value, after a period equal to A13 seconds from when the water valve is opened and for a period of A13 seconds from when the condition occurs. It is deactivated when the temperature remains above the setpoint + C37/2 (setpoint - C38/2) for a period of A13 x 10.</p> <p>It reverts to manual reset if the number of alarm events in an hour exceeds A05.</p> <p>Main results:</p> <ul style="list-style-type: none"> <li>- the associated water coil is switched off</li> </ul>
AL21	ASF	<p>Filter pressure switch alarm</p> <p>The alarm is activated if the input configured as filter pressure switch is active. It is deactivated if the input is inactive.</p> <p>Automatic alarm.</p> <p>Main results:</p> <ul style="list-style-type: none"> <li>- signal only</li> </ul>
AL23	ACnG	<p>Digital input congruence alarm</p> <p>The alarm is activated if the <i>Heat pump status</i> digital input is configured and the following settings are not applied:</p> <p><i>Heat pump status (NO)</i> = 1 and the machine is in heating mode  <i>Heat pump status (NC)</i> = 0 and the machine is in heating mode  <i>Heat pump status (NO)</i> = 0 and the machine is in cooling mode  <i>Heat pump status (NC)</i> = 1 and the machine is in cooling mode</p> <p>Automatic alarm.</p> <p>Main results:</p> <ul style="list-style-type: none"> <li>- the water valve is switched off</li> </ul>
AL24	AFir	<p>Fire alarm</p> <p>The alarm is activated if the input configured as <i>Fire Alarm</i> is active. It is deactivated if the input is not active.</p> <p>Manual alarm.</p> <p>Main results:</p> <ul style="list-style-type: none"> <li>- If C68 = 0 (fire management) all the loads are switched off</li> <li>- If C68 = 1 (smoke management) the coils are switched off, and the fans and the dampers are set to maximum.</li> </ul>

Code	Label on display	Description
AL33	EA01	Probe alarms (on devices from EA1 to EA07, T&H probes of the EA08 and EA09 displays, respectively). The alarm is activated in the following situations: - when a probe short circuits or is interrupted - if the upper or lower limits set for a probe are exceeded
AL34	EA02	
AL35	EA03	
AL36	EA04	
AL37	EA05	Non-configured analogue inputs do not cause alarms.
AL38	EA06	Automatic alarm
AL39	EA07	Main results:
AL40	EA08	- regulation involving faulty probes is interrupted
AL41	EA09	

## 13 ACCESSORIES

### 13.1 INTRABUS/RS-485 EVIF22ISX serial interface

Makes it possible to convert the INTRABUS signal into an RS-485 MODBUS signal (with INTRABUS communication protocol), to allow connecting cables device-user interface up to 1,000 m.

EVIF22ISX can also work as programming key, to allow EV3 MVC and EVD MVC configuration upload and download.



#### USE AS PROGRAMMING KEY

##### Configuration upload

1. Place micro-switch 1, 2 and 3 of the three-positions DIP in position ON and micro-switch 1 and 2 of the two-positions DIP in position ON.

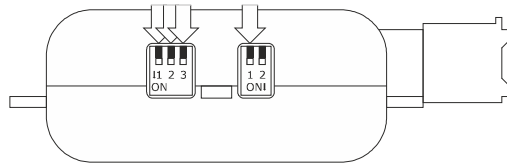

2. Disconnect the controller from the mains; see the relative instruction sheet.
3. Connect the device to the INTRABUS port of the controller as shown in the section ELECTRICAL CONNECTION, or:
  - connect terminal 1 to terminal "12 V"
  - connect terminal 2 to terminal "data INTRABUS"
  - connect terminal 3 to terminal "reference (GND)".
4. Power up the controller; see the relative instruction sheet.

The recognizing of the device will be run.

The recognizing normally takes a few seconds, when it is finished the green LED and the red LED will firmly switch on.

Later the configuration upload will be run.

The upload normally takes a few seconds. If the upload is successfully completed, the green LED switches on firmly and the red LED switches off; vice versa if the upload fails, the green LED switches off and the red LED switches on firmly (repeat the upload).



## Configuration download

N.B.

- the configuration download is allowed on condition that the firmware of the controller of origin coincides with the firmware of the controller of destination
  - if the configuration download fails, it could be necessary to restore the factory settings (default) of the controller; see the relative instruction sheet.
1. Place micro-switch 1, 2 and 3 of the three-positions DIP in position OFF and micro-switch 1 and 2 of the two-positions DIP in position ON.

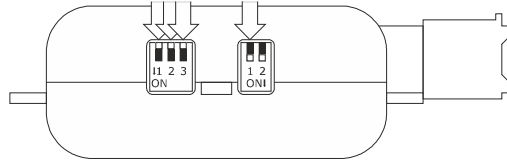

2. Disconnect the controller from the mains; see the relative instruction sheet.
3. Connect the device to the INTRABUS port of the controller as shown in the section ELECTRICAL CONNECTION, or:
  - connect terminal 1 to terminal "12 V"
  - connect terminal 2 to terminal "data INTRABUS"
  - connect terminal 3 to terminal "reference (GND)".
4. Power up the controller; see the relative instruction sheet.
 

The recognizing of the device will be run.

The recognizing normally takes a few seconds, when it is finished the green LED and the red LED will firmly switch on.

Later the configuration download will be run.

The download normally takes a few seconds. If the download is successfully completed, the green LED switches on firmly and the red LED switches off; vice versa if the download fails, the green LED switches off and the red LED switches on firmly (repeat the upload).

For further information see the relative instruction sheet.

## 13.2 RS-485/USB EVIF20SUXI serial interface

This interface makes it possible to connect EV3 MVC and EVD MVC to the Parameters Manager set-up software system.



### 13.3 0025100010 drip protector

This drip protector shields EV3 MVC and EV3K11 from damp.



### 13.4 CJAV connection kit

These kits make it possible to cable EV3 MVC and EVD MVC.

Device	Connection kit (purchasing code)
EV3 MVC	CJAV39
EVD MVC	CJAV38



## 14 TECHNICAL SPECIFICATIONS

<b>Purpose of the control device</b>	EV3 MVC	Function controller
	EVD MVC	
	EV3K11	
	EVJ LCD	
<b>Construction of the control device</b>	EV3 MVC	Built-in electronic device
	EVD MVC	
	EV3K11	
	EVJ LCD	
<b>Housing</b>	EV3 MVC	Black, self-extinguishing
	EVD MVC	Grey, self-extinguishing
	EV3K11	Black, self-extinguishing
	EVJ LCD	White, self-extinguishing
<b>Category of heat and fire resistance</b>	EV3 MVC	D
	EVD MVC	
	EV3K11	
	EVJ LCD	
<b>Measurements</b>	EV3 MVC	75.0 x 33.0 x 59.0 mm (2.952 x 1.299 x 2.322 in)
	EVD MVC	71.0 x 110.0 x 60.0mm (2.795 x 4.330 x 2.362 in); 4 DIN modules
	EV3K11	75.0 x 33.0 x 39.5 mm (2.952 x 1.299 x 1.555 in)
	EVJ LCD	111.4 x 76.4 x 18.5 mm (4.384 x 3.007 x 0.727 in)
<b>Mounting methods for the control device</b>	EV3 MVC	To be fitted to a panel, snap-in brackets provided
	EVD MVC	On a DIN rail 35.0 x 7.5 mm (1.377 x 0.295 in) or 35.0 x 15.0 mm (1.377 x 0.590 in), in a control panel
	EV3K11	To be fitted to a panel, snap-in brackets provided
	EVJ LCD	Wall-mounted (with fixing screws and plugs) or in a built-in 502E or 503E box (with fixing screws)
<b>Degree of front protection</b>	EV3 MVC	IP65
	EVD MVC	IP40
	EV3K11	IP65
	EVJ LCD	IP30
<b>Connections</b>	EV3 MVC	<ul style="list-style-type: none"> <li>- Micro-Fit connector (power supply, analogue inputs, digital inputs, analogue outputs and INTRABUS port)</li> <li>- Edge connectors (digital outputs)</li> <li>- Plug-in screw terminal block (RS-485 MODBUS port).</li> </ul>
	EVD MVC	<ul style="list-style-type: none"> <li>- Micro-Fit connector (analogue inputs, digital inputs, open collector output)</li> <li>- Plug-in screw terminal blocks (power supply, electro-mechanical relays, INTRABUS port and RS-485 MODBUS port).</li> </ul>
	EV3K11	Plug-in screw terminal block (power supply and INTRABUS port).
	EVJ LCD	Fixed screw terminal block (power supply and INTRABUS port).

	<p>The maximum lengths of the connection cables are as follows:</p> <ul style="list-style-type: none"> <li>- power supply: 10 m (32.8 ft)</li> <li>- analogue inputs: 10 m (32.8 ft)</li> <li>- power supply for transducer analogue inputs 4-20 mA: 10 m (32.8 ft)</li> <li>- digital inputs: 10 m (32.8 ft)</li> <li>- analogue outputs 0-10 V: 10 m (32.8 ft)</li> <li>- phase cutting analogue outputs: 10 m (32.8 ft)</li> <li>- PWM analogue outputs: 1 m (3.28 ft)</li> <li>- digital outputs: 10 m (32.8 ft)</li> <li>- INTRABUS ports: 10 m (32.8 ft)</li> <li>- RS-485 MODBUS ports: 1,000 m (3,280 ft); see also the <i>MODBUS manual "specifications and implementation guides"</i> available on <a href="http://www.MODBUS.org/specs.php">http://www.MODBUS.org/specs.php</a>.</li> <li>- USB port, 1 m (3.28 ft)</li> </ul> <p>Use cables of an adequate section for the current running through them.</p> <p>For EV3 MVC cabling we recommend using the CJAV39 connection kit (to be ordered separately). For EVD MVC cabling instead, we recommend using the CJAV38 connection kit (to be ordered separately).</p>	
<b>Operating temperature:</b>	EV3 MVC	from -10 to 55 °C (from 14 to 131 °F)
	EVD MVC	from -10 to 55 °C (from 14 to 131 °F)
	EV3K11	from 0 to 55 °C (from 32 to 131 °F)
	EVJ LCD	from 0 to 40 °C (from 32 to 104 °F)
<b>Storage temperature:</b>	EV3 MVC	from -20 to 70 °C (from -4 to 158 °F)
	EVD MVC	
	EV3K11	
	EVJ LCD	
<b>Operating humidity:</b>	EV3 MVC	Relative humidity without condensate from 10 to 90%
	EVD MVC	
	EV3K11	
	EVJ LCD	Relative humidity without condensate from 5 to 95%
<b>Pollution status of the control device:</b>	EV3 MVC	2
	EVD MVC	
	EV3K11	
	EVJ LCD	
<b>Compliance:</b>	EV3 MVC	- RoHS 2011/65/EC
	EVD MVC	- WEEE 2012/19/EU
	EV3K11	- REACH (EC) Regulation no. 1907/2006
	EVJ LCD	- EN 60730-1 - IEC 60730-1 - R&TTE 1999/5/EC (only applicable for EVJ LCD)
<b>Power supply:</b>	EV3 MVC	12 VAC (+10 -15%), 50/60 Hz (±3 Hz), max. 7 VA not insulated Protect the power supply with a 1 A-T 250 V fuse
	EVD MVC	115... 230 VAC (+10% -15%), 50/60 Hz (±3 Hz), max. 6 VA insulated Protect the power supply with a 2 A-T 250 V fuse
	EV3K11	- 12 VAC (±15%), 50/60 Hz (±3 Hz), max. 5 VA not insulated - 12 VDC (±15%), max. 5 W not insulated Protect the power supply with a 1 A-T 250 V fuse

	EVJ LCD	- 12 VAC ( $\pm 15\%$ ), 50/60 Hz ( $\pm 3$ Hz), max. 10 VA not insulated - 12 VDC ( $\pm 15\%$ ), max. 10 W not insulated
<b>Rated impulse-withstand voltage:</b>	EV3 MVC	4 kV
	EVD MVC	
	EV3K11	
	EVJ LCD	
<b>Over-voltage category:</b>	EV3 MVC	III
	EVD MVC	II
	EV3K11	Not applicable
	EVJ LCD	III
<b>Software class and structure:</b>	EV3 MVC	A
	EVD MVC	
	EV3K11	
	EVJ LCD	
<b>Clock:</b>	EV3 MVC	On request (with secondary lithium battery) Battery autonomy in the absence of a power supply: > 6 months at 25 °C (77 °F)
	EVD MVC	Battery charging time: 24 h (the battery is charged by the power supply of the device) Drift: $\leq 60$ s/month at 25 °C (77 °F)
	EV3K11	not available
	EVJ LCD	not available
<b>Analogue inputs:</b>	EV3 MVC	7 inputs:
	EVD MVC	- 5 for NTC or dry contact probe - 2 for NTC/4-20 mA/0-10 V or dry contact probe
	EV3K11	none
	EVJ LCD	none
	<u>NTC analogue inputs (10 K<math>\Omega</math> @ 25 °C, 77 °F)</u>	
	Sensor type: $\beta 3435$	
	Measurement field: from -50 to 150 °C (from -58 to 248 °F)	
	Precision: $\pm 0.5^\circ\text{C}$ from -20 to 40°C, $\pm 1^\circ\text{C}$ from -40 to 120°C, $\pm 2^\circ\text{C}$ from -50 to 150°C	
	Resolution: 0.1 °C	
	Protection: none	
<u>Analogue inputs 4-20 mA</u>		
Input resistance: $\leq 200 \Omega$		
Resolution: 0.02 mA		
Protection: none; the maximum current permitted on each input is 25 mA		
<u>Analogue inputs 0-10 V</u>		
Input resistance: > 10 K $\Omega$ .		
Measurement field: from 0.00 to 12.00 V		
Precision: 0.1 V		
Resolution: 0.02 V		
Protection: none; the maximum current permitted on each input is 12.5 V		
<b>Digital inputs:</b>	EV3 MVC	3 inputs:
	EVD MVC	- 2 dry contact/tachometric - 1 dry contact

	EV3K11	none	
	EVJ LCD	none	
	<p><u>Dry contact digital inputs (5 VDC, 1.5 mA)</u>                      Power supply: none                      Protection: none                      Minimum ON time for fast inputs to detect the pulse: 2.5 ms</p>		
<b>Analogue outputs:</b>	EV3 MVC	2 for 0-10 V/PWM/phase cutting	
	EVD MVC		
	EV3K11	none	
	EVJ LCD	none	
	<p><u>Analogue outputs 0-10 V (max. 10 mA)</u>                      Minimum load impedance: 1 KΩ                      Resolution: 0.01 V                      Protection: none</p>		
	<p><u>Phase cutting analogue outputs</u>                      Output: 10 VDC, max. 10 mA                      Frequency: synchronised with that of the power supply                      Pulse duration: 500 μs                      Shift: 20... 90%                      Protection: none</p>		
	<p><u>PWM analogue outputs</u>                      Output: 10 VDC, max. 10 mA                      Frequency: 10... 2 KHz                      Duty: 5... 95%                      Protection: none</p>		
	<p><u>Frequency analogue outputs</u>                      Output: 10 VDC, max. 10 mA                      Frequency: 10 Hz ... 255 Hz                      Duty: 50%                      Protection: none</p>		
	<b>Digital outputs:</b>	EV3 MVC	Up to 6 outputs: - 4 SPST relays, 3 A res. @ 250 VAC - 1 200 mA triac res. @ 250 VAC at 25°C (77°F) - 1 2 A triac res. @ 250 VAC at 25°C (77°F)
		EVD MVC	Up to 5 outputs: - 2 SPST relays, 3 A res. @ 250 VAC - 1 SPST relay, 8 A res. @ 250 VAC - 1 SPST relay, 12 A res. @ 250 VAC - 1 open collector, 12 VDC, max. 40 mA
EV3K11		none	
EVJ LCD		none	
<b>Type 1 or Type 2 Actions</b>	EV3 MVC	Type 1	
	EVD MVC		
	EV3K11	Not applicable	
	EVJ LCD	Not applicable	
<b>Additional features of Type</b>	EV3 MVC	C	

<b>1 or Type 2 actions</b>	EVD MVC	
	EV3K11	Not applicable
	EVJ LCD	Not applicable
<b>Displays</b>	EV3 MVC EVD MVC	4+4 digit LED display
	EVD MVC	Signalling LED
	EV3K11	4+4 digit LED display
	EVJ LCD	3+4 digit LCD display
<b>Communications ports</b>	EV3 MVC	Up to 2 ports: - 1 INTRABUS port - 1 RS-485 MODBUS port (optional)
	EVD MVC	Up to 2 ports: - 1 INTRABUS port - 1 RS-485 MODBUS port (optional)
	EV3K11	1 INTRABUS port
	EVJ LCD	1 INTRABUS port or RS-485 with INTRABUS communication protocol
<b>Alarm buzzer</b>	EV3 MVC	Built-in
	EVD MVC	not available
	EV3K11	Built-in
	EVJ LCD	Built-in
<b>Built-in sensors:</b>	EV3 MVC	none
	EVD MVC	none
	EV3K11	none
	EVJ LCD	- Bluetooth Low Energy (optional) - temperature and humidity (optional)
<b>Built-in temperature and humidity sensor measurement field:</b>	EV3 MVC	not available
	EVD MVC	not available
	EV3K11	not available
	EVJ LCD	- 0... 40 °C (32... 104 °F) - 10... 90% relative humidity





EV3 MVC & EVD MVC

Controllers for mechanical ventilation units for air renewal and heat recovery

Application manual ver. 2.2c

GA - 47/19

Code 1443DMVCI224

This document and the solutions contained therein are the intellectual property of EVCO and thus protected by the Italian Intellectual Property Rights Code (CPI). EVCO imposes an absolute ban on the full or partial reproduction and disclosure of the content other than with the express approval of EVCO. The customer (manufacturer, installer or end-user) assumes all responsibility for the configuration of the device. EVCO accepts no liability for any possible errors in this document and reserves the right to make any changes, at any time without prejudice to the essential functional and safety features of the equipment.



**EVCO S.p.A.**

Via Feltre 81, 32036 Sedico Belluno ITALY

Tel. 0437/8422 | Fax 0437/83648

info@evco.it | www.evco.it